

**0690-**

**LLAVE COMBINADA CON CABEZA INCLINABLE A CARRACA**



Art.	€	Medida	Longitud
0690/08	€ 11,40	8 mm	150 mm
0690/09	€ 11,40	9 mm	150 mm
0690/10	€ 14,20	10 mm	160 mm
0690/11	€ 14,20	11 mm	170 mm
0690/12	€ 14,20	12 mm	170 mm
0690/13	€ 14,20	13 mm	185 mm
0690/14	€ 18,10	14 mm	205 mm
0690/15	€ 18,10	15 mm	205 mm
0690/16	€ 18,10	16 mm	230 mm
0690/17	€ 19,40	17 mm	230 mm
0690/18	€ 20,50	18 mm	250 mm
0690/19	€ 21,80	19 mm	250 mm

**0700-**

**LLAVE COMBINADA CON CABEZA A CARRACA**

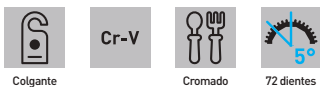

Art.	€	Medida	Longitud
0700/08	€ 9,00	8 mm	140 mm
0700/09	€ 9,10	9 mm	150 mm
0700/10	€ 9,20	10 mm	160 mm
0700/11	€ 10,10	11 mm	165 mm
0700/12	€ 10,50	12 mm	172 mm
0700/13	€ 11,20	13 mm	180 mm
0700/14	€ 12,00	14 mm	190 mm
0700/15	€ 12,70	15 mm	220 mm
0700/16	€ 13,50	16 mm	221 mm
0700/17	€ 14,90	17 mm	225 mm
0700/18	€ 15,30	18 mm	238 mm
0700/19	€ 15,90	19 mm	248 mm

**0690/07P**

**€ 104,00**

**JUEGO DE LLAVES COMBINADAS CON CABEZA INCLINABLE A CARRACA**



**Medidas** 8 - 10 - 11 - 13 - 15 - 17 - 19 mm

**0690/12P**

**€ 166,00**

**JUEGO DE LLAVES COMBINADAS CON CABEZA INCLINABLE A CARRACA**

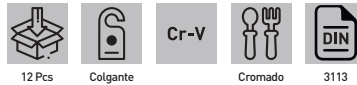

**Medidas** 8 - 9 - 10 - 11 - 12 - 13 - 14 - 15 - 16 - 17 - 18 - 19 mm

**0700/07P**

**€ 72,80**

**JUEGO DE LLAVES COMBINADAS A CARRACA**

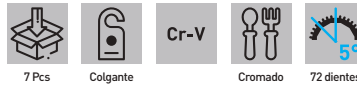

**Medidas** 8 - 10 - 11 - 13 - 15 - 17 - 19 mm

**0700/12P**

**€ 131,00**

**JUEGO DE LLAVES COMBINADAS A CARRACA**



**Medidas** 8 - 9 - 10 - 11 - 12 - 13 - 14 - 15 - 16 - 17 - 18 - 19 mm



**0201-**  
**LLAVES DE DOS BOCAS CROMADAS LUSTRADAS A ESPEJO**



Art.	€	Medida	Longitud
0201/06X07	€ 2,09	6 x 7 mm	122 mm
0201/08X09	€ 2,73	8 x 9 mm	140 mm
0201/10X11	€ 2,73	10 x 11 mm	156 mm
0201/12X13	€ 3,93	12 x 13 mm	172 mm
0201/14X15	€ 3,93	14 x 15 mm	190 mm
0201/16X17	€ 4,86	16 x 17 mm	190 mm
0201/18X19	€ 5,90	18 x 19 mm	225 mm
0201/20X22	€ 6,70	20 x 22 mm	235 mm
0201/21X23	€ 7,90	21 x 23 mm	250 mm
0201/24X27	€ 8,50	24 x 27 mm	265 mm

Art.	€	Medida	Longitud
0201/25X28	€ 10,70	25 x 28 mm	280 mm
0201/30X32	€ 11,30	30 x 32 mm	300 mm
0201/32X36	€ 12,50	32 x 36 mm	325 mm
0201/34X36	€ 13,30	34 x 36 mm	325 mm
0201/35X38	€ 14,40	35 x 38 mm	330 mm
0201/36X41	€ 16,30	36 x 41 mm	360 mm
0201/41X46	€ 27,70	41 x 46 mm	400 mm
0201/46X50	€ 37,30	46 x 50 mm	450 mm
0201/50X55	€ 54,40	50 x 55 mm	485 mm
0201/55X60	€ 62,00	55 x 60 mm	520 mm

**0200** € 33,50  
**JUEGO DE LLAVES DE DOS BOCAS CROMADAS LUSTRADAS A ESPEJO**



Medidas 6x7 - 8x9 - 10x11 - 12x13 - 14x15 - 16x17 - 18x19 - 20x22 mm

**0201** € 77,50  
**JUEGO DE LLAVES DE DOS BOCAS CROMADAS LUSTRADAS A ESPEJO**

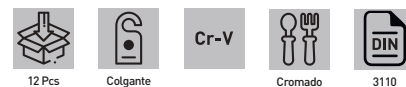

Medidas 6x7 - 8x9 - 10x11 - 12x13 - 14x15 - 16x17 - 18x19 - 20x22 - 21x23 - 24x27 - 25x28 - 30x32 mm

**0208-**
**LLAVES COMBINADAS CROMADAS Y LUSTRADAS A ESPEJO**

Art.	€	Medida	Longitud
0208/06	€ 3,93	6 mm	100 mm
0208/07	€ 3,93	7 mm	110 mm
0208/08	€ 3,93	8 mm	120 mm
0208/09	€ 3,93	9 mm	130 mm
0208/10	€ 4,02	10 mm	140 mm
0208/11	€ 4,02	11 mm	150 mm
0208/12	€ 4,02	12 mm	160 mm
0208/13	€ 4,02	13 mm	170 mm
0208/14	€ 6,00	14 mm	180 mm
0208/15	€ 6,00	15 mm	190 mm
0208/16	€ 6,00	16 mm	200 mm
0208/17	€ 6,70	17 mm	210 mm
0208/18	€ 6,70	18 mm	220 mm
0208/19	€ 7,90	19 mm	230 mm
0208/20	€ 9,80	20 mm	240 mm
0208/21	€ 9,80	21 mm	250 mm
0208/22	€ 11,30	22 mm	260 mm
0208/23	€ 11,90	23 mm	270 mm
0208/24	€ 12,80	24 mm	280 mm
0208/25	€ 12,80	25 mm	290 mm
0208/26	€ 12,80	26 mm	300 mm
0208/27	€ 14,00	27 mm	310 mm
0208/28	€ 14,00	28 mm	320 mm
0208/30	€ 14,00	30 mm	340 mm
0208/32	€ 16,00	32 mm	360 mm
0208/34	€ 17,10	34 mm	380 mm
0208/36	€ 18,20	36 mm	400 mm
0208/38	€ 20,10	38 mm	400 mm
0208/41	€ 25,80	41 mm	440 mm
0208/46	€ 35,30	46 mm	490 mm
0208/50	€ 41,20	50 mm	530 mm

**0199P-**
**LLAVES COMBINADAS CROMADAS Y LUSTRADAS A ESPEJO**

Pulgadas.



Art.	€	Medida	Longitud
0199P/1/4	€ 2,32	1/4"	100 mm
0199P/5/16	€ 2,54	5/16"	120 mm
0199P/3/8	€ 3,17	3/8"	140 mm
0199P/7/16	€ 3,28	7/16"	150 mm
0199P/1/2	€ 3,28	1/2"	170 mm
0199P/9/16	€ 4,13	9/16"	180 mm
0199P/5/8	€ 4,77	5/8"	200 mm
0199P/11/16	€ 4,98	11/16"	210 mm
0199P/3/4	€ 5,70	3/4"	230 mm
0199P/13/16	€ 6,70	13/16"	250 mm
0199P/7/8	€ 7,40	7/8"	260 mm
0199P/15/16	€ 10,70	15/16"	280 mm
0199P/1	€ 11,20	1"	290 mm

**0199**

€ 55,20

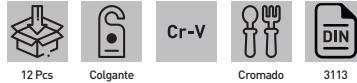
**JUEGO DE LLAVES COMBINADAS CROMADAS Y LUSTRADAS A ESPEJO**

**Medidas** 6 - 7 - 8 - 9 - 10 - 11 - 12 - 13 - 14 - 17 - 19 - 22 mm

**0208**

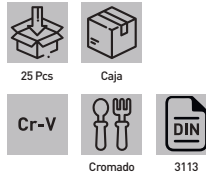
€ 132,00

**JUEGO DE LLAVES COMBINADAS CROMADAS Y LUSTRADAS A ESPEJO**

**Medidas** 6-7-8-9-10-11-12-13-14-15-16-17-18-19-20-21-22-23-24-25-26-27-28-30-32 mm

**0204**

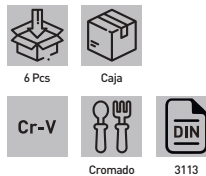
€ 169,00

**JUEGO DE LLAVES COMBINADAS CROMADAS Y LUSTRADAS A ESPEJO**

**Medidas** 34 - 36 - 38 - 41 - 46 - 50 mm

**0199P**

€ 65,30

**JUEGO DE LLAVES COMBINADAS CROMADAS Y LUSTRADAS A ESPEJO**

Pulgadas.

**Medida** 1/4" - 5/16" - 3/8" - 7/16" - 1/2" - 9/16" - 5/8" - 11/16" - 3/4" - 13/16" - 7/8" - 15/16" - 1"

**0222-**

**LLAVES DE DOS BOCAS**



Art.	€	Medida	Longitud
0222/06X07	€ 1,44	6 x 7 mm	122 mm
0222/08X09	€ 1,67	8 x 9 mm	140 mm
0222/10X11	€ 1,90	10 x 11 mm	155 mm
0222/12X13	€ 2,14	12 x 13 mm	170 mm
0222/14X15	€ 2,27	14 x 15 mm	190 mm
0222/16X17	€ 2,74	16 x 17 mm	205 mm
0222/18X19	€ 3,10	18 x 19 mm	220 mm
0222/20X22	€ 3,57	20 x 22 mm	235 mm
0222/21X23	€ 4,77	21 x 23 mm	250 mm
0222/24X27	€ 7,90	24 x 27 mm	265 mm
0222/25X28	€ 7,90	25 x 28 mm	280 mm
0222/30X32	€ 8,60	30 x 32 mm	300 mm

**0221**

**€ 17,50**

**JUEGO DE LLAVES DE DOS BOCAS**



Medidas 6x7 - 8x9 - 10x11 - 12x13 - 14x15 - 16x17 - 18x19 - 20x22 mm

**0224-**

**LLAVES COMBINADAS**



Art.	€	Medida	Longitud
0224/06	€ 1,31	6 mm	100 mm
0224/07	€ 1,31	7 mm	110 mm
0224/08	€ 1,31	8 mm	120 mm
0224/09	€ 1,38	9 mm	130 mm
0224/10	€ 1,44	10 mm	140 mm
0224/11	€ 1,75	11 mm	150 mm
0224/12	€ 1,75	12 mm	160mm
0224/13	€ 1,75	13 mm	170 mm
0224/14	€ 2,17	14 mm	180 mm
0224/15	€ 2,17	15 mm	190 mm
0224/16	€ 2,17	16 mm	200 mm
0224/17	€ 2,17	17 mm	210 mm
0224/18	€ 2,17	18 mm	220 mm
0224/19	€ 3,70	19 mm	230 mm
0224/20	€ 5,50	20 mm	240 mm
0224/21	€ 5,70	21 mm	250 mm
0224/22	€ 5,70	22 mm	260 mm
0224/23	€ 5,80	23 mm	270 mm
0224/24	€ 5,80	24 mm	280 mm
0224/25	€ 6,40	25 mm	290 mm
0224/26	€ 7,20	26 mm	300 mm
0224/27	€ 8,30	27 mm	310 mm
0224/28	€ 9,80	28 mm	320 mm
0224/30	€ 10,40	30 mm	340 mm
0224/32	€ 11,90	32 mm	360 mm
0224/34	€ 12,80	34 mm	380 mm
0224/36	€ 18,20	36 mm	400 mm

**0222**

**€ 42,40**

**JUEGO DE LLAVES DE DOS BOCAS**



Medidas 6x7 - 8x9 - 10x11 - 12x13 - 14x15 - 16x17 - 18x19 - 20x22 - 21x23 - 24x27 - 25x28 - 30x32 mm

**0073**

**€ 19,00**

**JUEGO DE LLAVES COMBINADAS**



Medidas 6 - 7 - 8 - 9 - 10 - 11 - 12 - 13 - 14 - 17 - 19 - 22 mm

**0544**

**€ 145,00**

**JUEGO DE LLAVES COMBINADAS CROMADAS CON CABEZA INCLINADA**

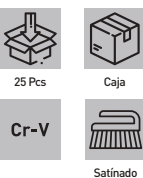

Medidas 6-7-8-9-10-11-12-13-14-15-16-17-18-19-20-21-22-23-24-25-26-27-28-30-32 mm

**0223**

**€ 75,20**

**JUEGO DE LLAVES COMBINADAS**

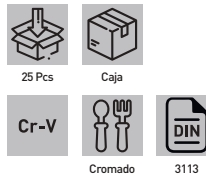

Medidas 6-7-8-9-10-11-12-13-14-15-16-17-18-19-20-21-22-23-24-25-26-27-28-30-32 mm

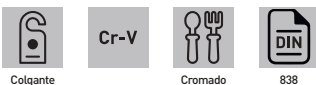
**0476-**
**LLAVES DE ESTRELLA ACODADAS A DOS BOCAS CROMADAS Y LUSTRADAS A ESPEJO**

Art.	€	Medida	Longitud
0476/06X07	€ 2,40	6 x 7 mm	165 mm
0476/08X09	€ 2,61	8 x 9 mm	180 mm
0476/10X11	€ 2,73	10 x 11 mm	195 mm
0476/12X13	€ 2,85	12 x 13 mm	215 mm
0476/14X15	€ 3,50	14 x 15 mm	240 mm
0476/16X17	€ 3,93	16 x 17 mm	260 mm
0476/18X19	€ 4,35	18 x 19 mm	320 mm
0476/20X22	€ 6,10	20 x 22 mm	320 mm
0476/21X23	€ 6,60	21 x 23 mm	325 mm
0476/24X27	€ 8,50	24 x 27 mm	335 mm
0476/25X28	€ 9,80	25 x 28 mm	345 mm
0476/30X32	€ 11,90	30 x 32 mm	360 mm

**0477**
**€ 29,50**
**JUEGO DE LLAVES DE ESTRELLA ACODADAS A DOS BOCAS**

**Medidas** 6x7 - 8x9 - 10x11 - 12x13 - 14x15 - 16x17 - 18x19 - 20x22 mm

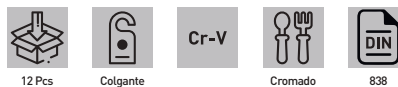
**0476**
**€ 67,60**
**JUEGO DE LLAVES DE ESTRELLA ACODADAS DE DOS BOCAS**

**Medidas** 6x7 - 8x9 - 10x11 - 12x13 - 14x15 - 16x17 - 18x19 - 20x22 - 21x23 - 24x27 - 25x28 - 30x32 mm

**0895-**
**LLAVES ABIERTAS DE PERCUSIÓN**



Art.	€	Medida	Longitud
0895/24	€ 13,50	24 mm	160 mm
0895/27	€ 14,60	27 mm	180 mm
0895/30	€ 16,30	30 mm	195 mm
0895/32	€ 17,50	32 mm	195 mm
0895/36	€ 20,70	36 mm	215 mm
0895/38	€ 23,20	38 mm	215 mm
0895/41	€ 26,50	41 mm	235 mm
0895/46	€ 30,10	46 mm	255 mm
0895/50	€ 41,20	50 mm	280 mm
0895/55	€ 47,70	55 mm	310 mm
0895/60	€ 57,10	60 mm	320 mm
0895/65	€ 80,40	65 mm	345 mm
0895/70	€ 101,00	70 mm	370 mm

**0896-**
**LLAVES DE PERCUSIÓN POLIGONALES**

Art.	€	Medida	Longitud
0896/24	€ 13,50	24 mm	160 mm
0896/27	€ 14,60	27 mm	180 mm
0896/30	€ 16,30	30 mm	195 mm
0896/32	€ 17,50	32 mm	195 mm
0896/36	€ 20,70	36 mm	205 mm
0896/38	€ 23,20	38 mm	215 mm
0896/41	€ 26,50	41 mm	230 mm
0896/46	€ 30,10	46 mm	240 mm
0896/50	€ 37,10	50 mm	255 mm
0896/55	€ 42,30	55 mm	270 mm
0896/60	€ 51,90	60 mm	280 mm
0896/65	€ 75,20	65 mm	300 mm
0896/70	€ 94,30	70 mm	325 mm

**0196-**

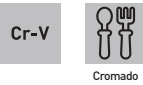
**LLAVES COMBINADAS CORTAS CROMADAS Y LUSTRADAS A ESPEJO**



Art.	€	Medida	Longitud
0196/10	€ 2,44	10 mm	95 mm
0196/11	€ 2,65	11 mm	105 mm
0196/12	€ 2,86	12 mm	105 mm
0196/13	€ 3,17	13 mm	110 mm
0196/14	€ 3,39	14 mm	115 mm
0196/15	€ 3,71	15 mm	115 mm
0196/16	€ 3,92	16 mm	125 mm
0196/17	€ 4,02	17 mm	130 mm
0196/18	€ 4,35	18 mm	140 mm
0196/19	€ 4,44	19 mm	140 mm

**0134-**

**LLAVES POLIGONAL PLANAS**



Art.	€	Medida	Longitud
0134/06X07	€ 3,81	6 x 7 mm	100 mm
0134/08X09	€ 4,23	8 x 9 mm	115 mm
0134/10X11	€ 4,44	10 x 11 mm	130 mm
0134/12X13	€ 4,77	12 x 13 mm	145 mm
0134/14X15	€ 5,20	14 x 15 mm	160 mm
0134/16X17	€ 5,70	16 x 17 mm	170 mm
0134/18X19	€ 6,10	18 x 19 mm	185 mm
0134/20X22	€ 6,80	20 x 22 mm	205 mm

**0196**

€ 27,70

**JUEGO DE LLAVES COMBINADAS CORTAS CROMADAS Y LUSTRADAS A ESPEJO**



Medidas 10-11-12-13-14-15-16-17-18-19 mm

**0134S**

€ 33,50

**JUEGO DE LLAVES DE DOS BOCAS PLANAS**

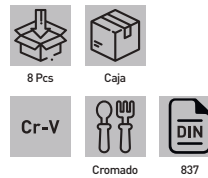

Medidas 100 - 6x7 mm, 115 - 8x9 mm, 130 - 10x11 mm, 145 - 12x13 mm, 160 - 14x15 mm, 170 - 16x17 mm, 185 - 18x19 mm, 205 - 20x20 mm

**0187**

€ 40,20

**JUEGO DE LLAVES COMBINADAS MULTILOCK**

Adecuados a tuercas y tornillos XZN, metricos, pulgadas y torx.

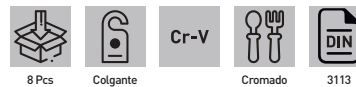

Medidas 8 - 10 - 11 - 12 - 13 - 14 - 17 - 19 mm  
 Medidas en 5/16" - 3/8" - 7/16" - 15/32"  
 pulgadas 1/2" - 9/16" - 11/16" - 3/4"  
 Medidas en torx E10 - E12 - E14 - E16 - E18 - E22 - E24  
 Medidas en XZN M8 - M10 - M11 - M12  
 M13 - M14 - M17 - M19

**0541S**

€ 30,80

**JUEGO DE LLAVES ABIERTAS DE DOS BOCAS**

6 caras de 8mm a 14mm, 12 caras de 17mm a 22mm.

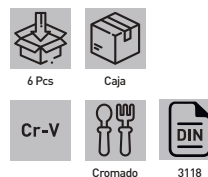

Medidas 140 - 8x10 mm, 150 - 9x11 mm, 175 - 11x13 mm, 175 - 12x14 mm, 210 - 17x19 mm, 220 - 19x22 mm

**0614-**

**LLAVES DE MEDIA LUNA**



Art.	€	Medida
0614/08X10	€ 4,77	8 x 10 mm
0614/10X12	€ 5,20	10 x 12 mm
0614/11X13	€ 5,60	11 x 13 mm
0614/13X15	€ 6,00	13 x 15 mm
0614/14X17	€ 7,10	14 x 17 mm
0614/16X18	€ 8,80	16 x 18 mm
0614/19X22	€ 9,60	19 x 22 mm

**0084-**

**LLAVES INGLESA CROMADAS**

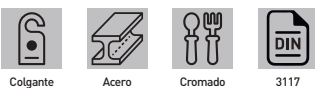

Art.	€	Medida	Apertura
0084/150	€ 5,70	6"-150 mm	20 mm
0084/250	€ 10,10	10"-250 mm	30 mm
0084/375	€ 28,50	15"-375 mm	48 mm

**0614**

**€ 47,70**

**JUEGO DE LLAVES DE MEDIA LUNA**

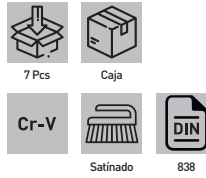

**Medidas** 8x10 - 10x12 - 11x13 - 13x15 - 14x17 - 16x18 - 19x22 mm

**0714**

**€ 125,00**

**JUEGO LLAVES DE GANCHO**



**Juego** 35+120  
**Medidas** 35+60 60+90 90+120

**0266**

**€ 1,66**

**LLAVE PARA BOMBONA DE GAS**



**Medida** 25 mm

**0340S**

**€ 61,30**

**JUEGO DE LLAVES DE VASO ARTICULADAS**

Ideal para desnudar o atornillar tuercas y pernos ubicados en posiciones difíciles para alcanzar.



**Medidas** 8x9-10x11-12x13-14x15-16x17-18x19 mm

**0393-**

**LLAVES DE PIPA DOBLES HEXAGONALES - POLIGONALES**



Art.	€	Medida	Longitud
0393/06	€ 6,00	6 mm	100 mm
0393/07	€ 6,00	7 mm	105 mm
0393/08	€ 6,00	8 mm	115 mm
0393/09	€ 6,20	9 mm	120 mm
0393/10	€ 6,40	10 mm	130 mm
0393/11	€ 7,10	11 mm	135 mm
0393/12	€ 7,50	12 mm	145 mm
0393/13	€ 8,10	13 mm	150 mm
0393/14	€ 8,60	14 mm	160 mm
0393/15	€ 9,00	15 mm	170 mm
0393/16	€ 9,50	16 mm	180 mm
0393/17	€ 10,20	17 mm	185 mm
0393/18	€ 11,30	18 mm	200 mm
0393/19	€ 12,20	19 mm	200 mm
0393/20	€ 13,70	20 mm	210 mm
0393/21	€ 14,40	21 mm	220 mm
0393/22	€ 15,50	22 mm	230 mm

**0442-**

**LLAVES DE TUBO EXAGONALES**

Lustrada a espejo con cuerpo exagonal.

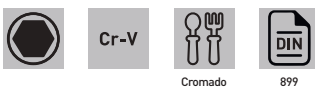

Art.	€	Medida	Longitud
0442/06X07	€ 7,10	6 x 7 mm	105 mm
0442/08X09	€ 7,70	8 x 9 mm	110 mm
0442/10X11	€ 8,30	10 x 11 mm	120 mm
0442/12X13	€ 9,20	12 x 13 mm	140 mm
0442/14X15	€ 10,40	14 x 15 mm	145 mm
0442/16X17	€ 11,90	16 x 17 mm	155 mm
0442/18X19	€ 14,50	18 x 19 mm	165 mm
0442/20X22	€ 18,20	20 x 22 mm	170 mm

**0393/A**

€ 108,00

**JUEGO DE LLAVES DE PIPA DOBLES HEXAGONALES - POLIGONALES**



Medidas 6-7-8-10-11-12-13-14-17-19 mm

**0393**

€ 80,40

**LLAVES DE PIPA DOBLES HEXAGONALES - POLIGONALES**



Medidas 6 - 7 - 8 - 10 - 11 - 12 - 13 - 14 - 17 - 19 - 22 mm

**0442**

€ 93,10

**JUEGO DE LLAVES DE TUBO EXAGONALES**

Lustradas a espejo con cuerpo hexagonal.



Medidas 105 - 6x7 mm, 110 - 8x9 mm, 120 - 10x11 mm, 140 - 12x13 mm, 145 - 14x15 mm, 155 - 16x17 mm, 165 - 18x19 mm, 170 - 20x22 mm

**0540-**

**LLAVES DE TUBO EXAGONALES**

Modelo ligero.



Art.	€	Medida	Longitud
0540/06X07	€ 2,23	6 x 7 mm	110 mm
0540/08X09	€ 2,35	8 x 9 mm	120 mm
0540/10X11	€ 2,39	10 x 11 mm	125 mm
0540/12X13	€ 2,54	12 x 13 mm	135 mm
0540/14X15	€ 2,71	14 x 15 mm	135 mm
0540/16X17	€ 3,17	16 x 17 mm	150 mm
0540/18X19	€ 3,57	18 x 19 mm	160 mm
0540/20X22	€ 3,98	20 x 22 mm	170 mm

**0540/3**

**€ 3,17**

**BANDEADOR ESCANALADO**

Para llaves de tubo.



Longitud	165 mm
Ø	9,5 - 7,5 - 6 mm

**0540S**

**€ 19,40**

**JUEGO DE LLAVES DE TUBO EXAGONALES**

Modelo ligero, con bandeador escanulado.

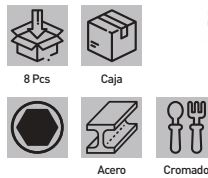

Medidas 6x7 - 8x9 - 10x11 - 12x13 - 14x15 - 16x17 - 18x19 - 20x22 mm

**0771**

**€ 9,90**

**LLAVE MULTIUSOS DE 4 VÍAS**

Llave multifunción para mantenimiento eléctrico, fontanería, ventilación y gas.



**0767**

**€ 19,90**

**LLAVE MULTIUSOS DE 8 VÍAS**

Llave multifunción para mantenimiento eléctrico, fontanería, ventilación y gas.



0090-

**LLAVES ACODADAS MACHOS**

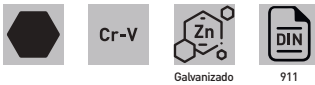
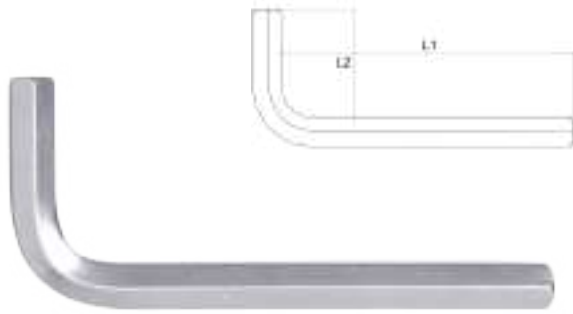

Art.	€	L1	L2	Pack
0090/015	€ 0,67	45 mm	15 mm	10
0090/02	€ 0,67	50 mm	16 mm	10
0090/025	€ 0,67	56 mm	18 mm	10
0090/03	€ 0,72	63 mm	19 mm	10
0090/04	€ 0,72	70 mm	25 mm	10
0090/05	€ 1,09	72 mm	25 mm	10
0090/06	€ 1,31	90 mm	30 mm	10
0090/08	€ 1,97	103 mm	38 mm	5
0090/10	€ 2,40	110 mm	38 mm	5
0090/12	€ 3,70	115 mm	44 mm	5
0090/14	€ 5,30	210 mm	54 mm	5
0090/17	€ 6,80	145 mm	59 mm	5
0090/19	€ 11,00	166 mm	65 mm	5

0545/EF

€ 34,40

**JUEGO DE LLAVES HEXÁGONO COLOREADAS A PUNTA DE BOLA**



Medidas 1,5 - 2 - 2,5 - 3 - 4 - 5 - 6 - 8 - 10 mm

0558/EM

€ 18,40

**JUEGO DE LLAVES ACODADAS CON PUNTA DE DIAMANTE**

La punta de diamante permite un agar perfecto, evitando desbocar la cabeza del tornillo. Este tipo de llave también es muy efectivo con los tornillos desbocados



Medidas 1,5 - 2 - 2,5 - 3 - 4 - 5 - 6 - 8 mm

0090

€ 2,96

**JUEGO DE LLAVES ACODADAS**



Medidas 1,5 - 2 - 2,5 - 3 - 3,5 - 4 - 5 - 6 - 8 - 10 mm

0269

€ 5,80

**JUEGO DE LLAVES ACODADAS**



Medidas 1,5 - 2 - 2,5 - 3 - 4 - 5 - 6 - 8 - 10 mm

0215X

**JUGO DE LLAVES ACODADAS LARGAS A PUNTA DE BOLA**



Art.	€	Medida
0215	€ 12,50	1,5 - 2 - 2,5 - 3 - 4 - 5 - 6 - 8 - 10 mm
0215P	€ 12,50	1/16" - 5/64" - 3/32" - 1/8" - 5/32" - 3/16" - 1/4" - 5/16" - 3/8"

0558/EP

€ 18,40

**JUEGO DE LLAVES ACODADAS CON PUNTA DE DIAMANTE**

El punto de diamante permite un agujero perfecto, evitando volver a la cabeza del tornillo. Este tipo de consejo también es muy efectivo con los tornillos ya arrendados.



Medidas 5/64" - 3/32" - 7/64" - 1/8" - 9/64" - 5/32" - 3/16" - 7/32" - 1/4"

**0558/GE**
**€ 14,60**
**JUEGO DE LLAVES ACODADAS**

Con boca de destornillador ph o recta, con mango multiuso que puede ser utilizado como un mango a t y una extensión de teclas.



Medidas	2 - 2,5 - 3 - 4 - 5 - 6 - 8 - 10 mm
Destornillador cruz	PH0 (3mm) - PH1 (4mm) - PH2 (5mm)
Destornillador boca recta	6mm

**0400**
**€ 69,80**
**JUEGO DE LLAVES DE 6 CARAS MACHO EN "T"**

Con mango corredizo, para usar en situaciones difíciles y condiciones severas.

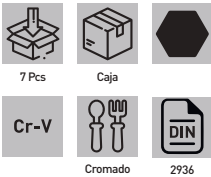

Medidas	2 - 3 - 4 - 5 - 6 - 8 - 10 mm
---------	-------------------------------

**0400-**
**LLAVES DE 6 CARAS MACHO EN "T"**

Con mango corredizo, para usar en situaciones difíciles y condiciones severas.



Art.	€	Medida	Dimensiones
0400/02	€ 9,10	2 mm	125 x 65 mm
0400/025	€ 9,10	2,5 mm	125 x 65 mm
0400/03	€ 9,10	3 mm	125 x 65 mm
0400/035	€ 9,10	3,5 mm	125 x 65 mm
0400/04	€ 9,80	4 mm	180 x 90 mm
0400/045	€ 9,80	4,5 mm	180 x 90 mm
0400/05	€ 9,80	5 mm	180 x 90 mm
0400/06	€ 10,30	6 mm	210 x 105 mm
0400/07	€ 10,30	7 mm	250 x 105 mm
0400/08	€ 11,90	8 mm	250 x 125 mm
0400/09	€ 14,40	9 mm	300 x 145 mm
0400/10	€ 14,40	10 mm	300 x 145 mm
0400/12	€ 20,40	12 mm	320 x 165 mm
0400/14	€ 26,00	14 mm	340 x 170 mm

**C856-**
**LLAVES ACODADAS CON MANGO DE PLASTICO A PUNTA DE BOLA**

Art.	€	Medida	Largo
C856/02.5	€ 4,23	2,5 mm	175 mm
C856/03	€ 4,23	3 mm	175 mm
C856/04	€ 4,44	4 mm	175 mm
C856/05	€ 4,77	5 mm	175 mm
C856/06	€ 6,70	6 mm	175 mm
C856/08	€ 7,40	8 mm	170 mm
C856/10	€ 10,20	10 mm	170 mm

**0190**
**€ 78,30**
**JUEGO DE LLAVES DE 6 CARAS MACHO EN T SPEEDY**

Las llaves hexagonales de aluminio cepillado y acero Cr-V de alta resistencia son ideales para tornillos hexagonal empotrados. Mango giratorio práctico "Speedy" para un agarre más firme y una mayor facilidad y rapidez de uso.



Medidas	2 - 3 - 4 - 5 - 6 - 8 - 10 mm
---------	-------------------------------

**0220**
**€ 14,70**
**JUEGO DE LLAVES ACODADAS TORX LARGAS**

Con agujero de guía.



Medidas	T10 - T15 - T20 - T25 - T27 - T30 - T40 - T45 - T50
---------	---

**0220/C**

€ 9,00

**JUEGO DE LLAVES ACODADAS TORX CORTAS**

Con agujero de guía.



Medidas

T10 - T15 - T20 - T25 - T27 - T30 - T40 - T45 - T50

**0545/TF**

€ 37,10

**JUEGO DE LLAVES TORX COLOREADAS**



Medidas

T10 - T15 - T20 - T25 - T27 - T30 - T40 - T45 - T50

**0558/TX**

€ 18,40

**JUEGO DE LLAVES ACODADAS TORX CON PUNTA DE DIAMANTE**

La punta de diamante permite un agarre perfecto, evitando desbocar la cabeza del tornillo. Este tipo de llave también es muy efectivo con los tornillos desbocados



Medidas

T9 - T10 - T15 - T20 - T25 - T27 - T30 - T40

**0405**

€ 70,80

**JUEGO DE LLAVES TORX MACHOS EN "T"**

Con mango corredizo, para usar en situaciones difíciles y condiciones severas.

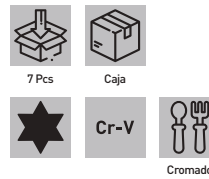

Medidas

T8 - T9 - T10 - T15 - T20 - T25 - T30

**C855-**

**LLAVES ACODADAS TORX CON MANGO DE PLASTICO**

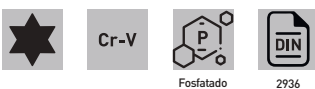

Art.	€	Medida	Largo
C855/T10	€ 4,23	T10	175 mm
C855/T15	€ 4,23	T15	175 mm
C855/T20	€ 4,77	T20	175 mm
C855/T25	€ 5,70	T25	175 mm
C855/T27	€ 5,70	T27	175 mm
C855/T30	€ 6,70	T30	175 mm
C855/T40	€ 8,50	T40	170 mm
C855/T50	€ 10,10	T50	170 mm

**0405-**

**LLAVE TORX MACHO EN "T"**

Con mango corredizo, para usar en situaciones difíciles y condiciones severas.

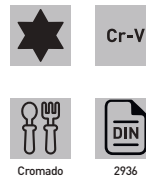

Art.	€	Medida	Longitud
0405/T06	€ 10,40	T06	125 mm
0405/T07	€ 10,40	T07	125 mm
0405/T08	€ 10,40	T08	125 mm
0405/T09	€ 10,40	T09	125 mm
0405/T10	€ 10,40	T10	125 mm
0405/T15	€ 10,40	T15	125 mm
0405/T20	€ 10,40	T20	125 mm
0405/T25	€ 10,70	T25	180 mm
0405/T27	€ 10,70	T27	180 mm
0405/T30	€ 10,70	T30	180 mm
0405/T40	€ 12,80	T40	210 mm
0405/T45	€ 14,00	T45	210 mm
0405/T50	€ 15,00	T50	210 mm

**0190T**

€ 74,60

**JUEGO DE LLAVES DE 6 TORX EN T "SPEEDY"**

Las llaves torx de aluminio cepillado y acero Cr-V de alta resistencia son ideales para tornillos torx empotrados. Mango giratorio práctico "Speedy" para un agarre más firme y una mayor facilidad y rapidez de uso.



Medidas T10 - T15 - T20 - T25 - T27 - T30 - T40

**0359-**

**LLAVE DE MECANICO**



Art.	€	Medida	Longitud
0359/14L	€ 24,40	14 mm	530 mm
0359/16L	€ 24,40	16 mm	530 mm
0359/21L	€ 26,50	20,8 mm	530 mm
0359/16	€ 20,10	16 mm	275 mm

**C245-**

**LLAVE DE VASO HEXAGONAL EN T**



Art.	€	Medida	Longitud
C245/06	€ 14,90	6 mm	320 mm
C245/07	€ 14,90	7 mm	320 mm
C245/08	€ 14,90	8 mm	320 mm
C245/09	€ 14,90	9 mm	320 mm
C245/10	€ 15,30	10 mm	320 mm
C245/11	€ 15,30	11 mm	320 mm
C245/12	€ 15,90	12 mm	320 mm
C245/13	€ 15,90	13 mm	320 mm
C245/14	€ 16,90	14 mm	320 mm
C245/17	€ 19,50	17 mm	320 mm
C245/19	€ 24,40	19 mm	320 mm

**C395-**

**LLAVE DE VASO HEXAGONAL ARTICULADA MAGNETICA EN T**

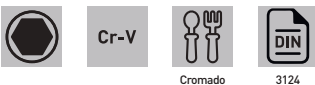

Art.	€	Medida	Longitud
C395/06	€ 18,60	6 mm	390 mm
C395/07	€ 18,60	7 mm	390 mm
C395/08	€ 18,60	8 mm	390 mm
C395/09	€ 18,60	9 mm	390 mm
C395/10	€ 21,00	10 mm	500 mm
C395/11	€ 21,00	11 mm	500 mm
C395/12	€ 21,00	12 mm	500 mm
C395/13	€ 21,90	13 mm	500 mm
C395/14	€ 21,90	14 mm	500 mm
C395/15	€ 24,90	15 mm	500 mm
C395/16	€ 24,90	16 mm	500 mm
C395/17	€ 24,90	17 mm	500 mm
C395/18	€ 25,90	18 mm	500 mm
C395/19	€ 27,50	19 mm	500 mm

**C391-**

**LLAVE DE VASO HEXAGONAL ARTICULADA EN T**

Para servicio pesado.



Art.	€	Medida	Longitud
C391/06	€ 21,20	6 mm	395 mm
C391/07	€ 21,20	7 mm	395 mm
C391/08	€ 21,20	8 mm	395 mm
C391/09	€ 21,20	9 mm	400 mm
C391/10	€ 23,20	10 mm	400 mm
C391/11	€ 23,20	11 mm	400 mm
C391/12	€ 23,20	12 mm	400 mm
C391/13	€ 25,40	13 mm	432 mm
C391/14	€ 25,40	14 mm	432 mm
C391/15	€ 30,80	15 mm	450 mm
C391/16	€ 30,80	16 mm	450 mm
C391/17	€ 30,80	17 mm	450 mm
C391/18	€ 30,80	18 mm	450 mm
C391/19	€ 33,90	19 mm	500 mm

**0352-**

**LLAVE DE CORREA PARA FILTROS DE ACEITE**



Art.	€	Diámetro máximo del filtro	Banda
0352/01	€ 21,00	180 mm	610 mm
0352/02	€ 22,80	220 mm	800 mm

**0357-**

**LLAV REGULABEL PARE FILTROS DE ACEITE**



Art.	€	Diámetro máximo del filtro	Banda
0357/01	€ 24,20	70 mm	180 mm
0357/02	€ 26,30	120 mm	200 mm

**0076**

**€ 4,77**

**EXTRACTOR DE FILTRO DE FLEJE**

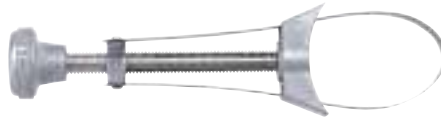

Diámetro máximo del filtro	100 mm
Banda	195 mm

**0077**

**€ 6,40**

**LLAVE DE FILTRO DE CADENA**



Diámetro máximo del filtro	110 mm
Banda	380 mm

**0018/15**

**€ 67,60**

**JUEGO DE EXTRACTORES PARA FILTROS DE ACEITE**

Útil para la remoción de filtros de aceite para muchos coches. Un amplificador con cuadradillo macho 3/8" y hembra 1/2" es incluido en el juego.

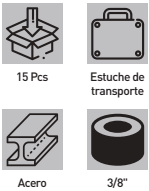

Medidas (ø mm - lados)	65 mm - 14, 65/67 mm - 14, 68 mm - 14, 74 mm - 15, 74/76 mm - 15, 75/77 mm - 15, 76 mm - 14, 76 mm - 30, 80 mm - 15, 80/82 mm
Cuadrillo amplificador	1/2" [F] 3/8" [M]

**0018/30**

**€ 150,00**

**JUEGO DE EXTRACTORES PARA FILTROS DE ACEITE**

Útil para la remoción de filtros de aceite para muchos coches. Un amplificador con cuadradillo macho 3/8" y hembra 1/2" y una llave de tres patas son incluidos en el juego.



Medidas (ø mm - lados)	65 mm - 14, 65/67 mm - 14, 66 mm - 6, 68 mm - 14, 73 mm - 14, 74 mm - 15, 74/76 mm - 15, 75/77 mm - 15, 76 mm - 8, 76 mm - 12, 76 mm - 14, 76 mm - 30, 78 mm - 15, 80 mm - 15, 80/82 mm - 15, 86 mm - 16, 86 mm - 18, 90 mm - 15, 92 mm - 10, 93 mm - 15, 93 mm - 36, 93 mm
Cuadrillo amplificador	1/2" [F] 3/8" [M]
Llave de tres patas	65 ± 120 mm

**0080**

**€ 9,80**

**LLAVE EN CRUZ**



Medidas	17 - 19 - 21 mm
Dimensiones	381 x 16 mm

**0426-**

**LLAVE DE CRUZ**

Para camiones, con llaves de vaso hexagonales.



Art.	€	Medidas	Dimensiones
0426/30	€ 35,30	24 - 27 - 30 mm	550 x 20 mm
0426/32	€ 44,70	24 - 27 - 32 mm	700 x 22 mm

**0806/200**
**€ 467,00**
**LLAVE DINAMOMETRICA DIGITAL PARA VERIFICAR EL PAR DE APRIETE**

Permite apriete en sentido horario y antihorario y un diagnóstico luminoso y sonido del estado de par / ángulo.



<b>ESCALAS DE MEDICIÓN:</b>	Nm / kgf-cm / lbf-ft / lbf-in
Capacidad	20 ÷ 200 Nm
Lectura	0,1 Nm
Precisión	± 2%, 10% @ 200 Nm
Ángulo de medición	0 ÷ 360°

Precisión ángulo	±1%
Modalidad operativa	Peak / Track
Memorias par - ángulo	5
Longitud	605 mm
Batería	4x 1,5 V AAA

**0809-**
**LLAVE DINAMOMÉTRICA DIGITAL PARA VERIFICAR EL PAR DE APRIETE**

Permite apriete en sentido horario y antihorario y diagnósticos luminosos y sonoros del estado de la pareja.



Art.	€	ESCALAS DE MEDICIÓN:	Capacidad	Lectura	Precisión	Modalidad operativa	Memorias	Conexión cuadro	Longitud	Batería
0809/030	€ 111,00	Nm / kgf-m / lbf-ft / lbf-in	6 ÷ 30 Nm	0,01 Nm	± 4%	Peak / Track	50	1/4"	200 mm	2 x 3 V CR2032
0809/080	€ 119,00	Nm / kgf-m / lbf-ft / lbf-in	16 ÷ 80 Nm	0,1 Nm	± 3%	Peak / Track	50	3/8"	230 mm	2 x 3 V CR2032
0809/100	€ 125,00	Nm / kgf-m / lbf-ft / lbf-in	20 ÷ 100 Nm	0,1 Nm	± 2%	Peak / Track	50	1/2"	275 mm	2 x 3 V CR2032

**0806/020**
**€ 114,00**
**ATTORNILLADOR DINAMOMETRICO CON INDICADOR DIGITAL**

Iso 6789-2017, permite apretar en sentido horario y antihorario, de sonido y vibración diagnóstico del estado de par alcanzado preestablecido.



<b>ESCALAS DE MEDICIÓN:</b>	Nm / lbf-ft / lbf-in
Capacidad	0 ÷ 20 Nm
Lectura	0,01 Nm
Precisión	± 2%
Modalidad operativa	Peak / Track
Auto apagado	5 min.
Longitud	175 mm
Batería	2 x 1,5 V AAA
Temperatura de funcionamiento	0 °C - 40 °C
Temperatura almacenamiento	-5 °C - 45 °C

**0268A**
**€ 102,00**
**MEDIDOR ELECTRÓNICO DIGITAL DE PAR DE APRIETE**

Herramienta de monitorización de torsión. Aplicado a una llave de trinquete, se puede utilizar como llave dinamométrica.. Retroiluminación y desactivación automática.

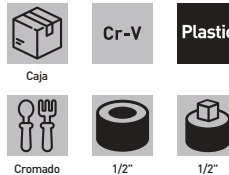

Modalidad operativa	Peak/track
<b>ESCALAS DE MEDICIÓN:</b>	Nm/kgm/kgcm/lbft/lbin
Capacidad	40 ÷ 200 Nm
Lectura	0,1 Nm
Memorias	50
Precisión	± 2%
Dimensiones	75 x 44mm
Batería	1 x 3 V CR2032
Temperatura de funcionamiento	-10°C-60 °C (14°F-139.9 °F)
Temperatura almacenamiento	-20°C -70°C (-4 °F-157.9°F)

**0774-**

NEW

**LLAVE DINAMOMETRICA**



Art.	€	Conexión	Capacidad	Lectura	Dientes	Longitud
0774/110	€ 40,00	3/8"	19 ÷ 110 Nm	0,5 Nm	45	370 mm
0774/210	€ 55,00	1/2" - 3/8"	28 ÷ 210 Nm	0,5 Nm	45	470 mm

**0779-**

NEW

**LLAVE DINAMOMETRICA**

Con selector de resorte.

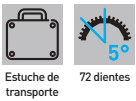

Art.	€	Conexión	Capacidad	Lectura	Precisión	Dientes	Longitud
0779/025	€ 75,00	1/4"	5 ÷ 25 Nm	0,2 Nm	± 3%	72	240 mm
0779/050	€ 85,00	3/8"	10 ÷ 50 Nm	0,5 Nm	± 3%	72	250 mm
0779/100	€ 95,00	3/8"	20 ÷ 100 Nm	1 Nm	± 3%	72	410 mm
0779/210	€ 125,00	1/2"	40 ÷ 210 Nm	1 Nm	± 3%	72	510 mm
0779/300	€ 130,00	1/2"	60 ÷ 300 Nm	2,5 Nm	± 3%	72	550 mm

**0778-**

NEW

**LLAVE DINAMOMETRICA**

Con doble ventana de lectura.



Art.	€	Conexión	Capacidad	Lectura	Precisión	Dientes	Longitud
0778/025	€ 90,00	1/4"	5 ÷ 25 Nm	0,2 Nm	± 3%	72	250 mm
0778/050	€ 95,00	3/8"	10 ÷ 50 Nm	0,5 Nm	± 3%	72	310 mm
0778/100	€ 105,00	3/8"	20 ÷ 100 Nm	0,5 Nm	± 3%	72	420 mm
0778/210	€ 145,00	1/2"	40 ÷ 210 Nm	1 Nm	± 3%	72	500 mm
0778/300	€ 155,00	1/2"	60 ÷ 300 Nm	1 Nm	± 3%	72	550 mm

**0779/S120**

€ 259,00

**LLAVE DINAMOMETRICA JUEGO**

Dotado de un trinquete reversible y cabezas de horquilla intercambiables, ideal para trabajos de precisión en espacios reducidos.



7 Pcs



Estuche de transporte



72 dientes



Llaves	17 - 22 - 24 - 26 - 27 - 30 mm
Conexión llaves	14 x 18 mm
Cabezal reversible	3/8"
Capacidad	20 ÷ 120 Nm
Lectura	1 Nm
Precisión	± 3%
Dientes	72
Longitud	390 mm

**0779/S210**

€ 339,00

**LLAVE DINAMOMETRICA JUEGO**

Dotado de un trinquete reversible y cabezas de horquilla intercambiables, ideal para trabajos de precisión en espacios reducidos.



10 Pcs



Estuche de transporte



72 dientes



Llaves	13-14-15-17-19-22-24-27-30 mm
Conexión llaves	14 x 18 mm
Cabezal reversible	1/2"
Capacidad	40 ÷ 210 Nm
Lectura	1 Nm
Precisión	± 3%
Dientes	72
Longitud	480 mm

**0329**

€ 180,00

**MULTIPLICADOR DE PAR**

De ahorro de llave de rueda.



7 Pcs



Estuche de transporte



3113



1"

Llaves de vaso de 1"	32 - 33 mm
Proporción	1:60
Fuerza máxima	3200 Nm
Fuerza de trabajo	1200 Nm
Peso neto	7,5 kg

**0360**

€ 81,60

**MULTIPLICADOR DE PAR**

De ahorro de llave de rueda, con maleta de plástico.



7 Pcs



Estuche de transporte



3113



1"

Llaves de vaso de 1"	32 - 33 mm
Proporción	1:56
Fuerza máxima	3000 Nm
Fuerza de trabajo	1000 Nm
Peso neto	7 kg





**CN450N0/0**

€ 48,90

**CARRACA REVERSIBLE A LIBERACION RAPIDA 3 EN 1**

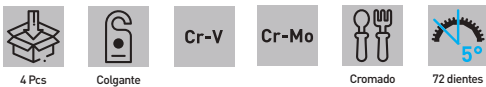

Longitud	230 mm
Conexión	1/2" - 3/8" - 1/4"
Dientes	72

**G090-**

**CARRACA ERGONOMICA**

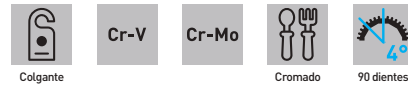

Art.	€	Longitud	Conexión cuadro
G090/1/4	€ 22,60	145 mm	1/4"
G090/3/8	€ 27,40	195 mm	3/8"
G090/1/2	€ 31,30	265 mm	1/2"

**0494-**

**CARRACA ERGONOMICA CON CABEZA A PRUEBA DE POLVO**

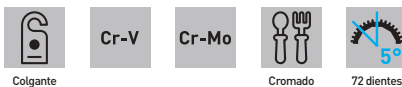

Art.	€	Longitud	Conexión cuadro
0494/1/4	€ 27,40	165 mm	1/4"
0494/3/8	€ 31,30	215 mm	3/8"
0494/1/2	€ 37,70	276 mm	1/2"

**CN450NX**

**CARRACA ERGONOMICA**

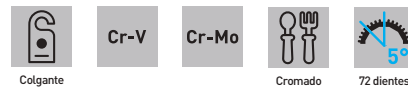

Art.	€	Longitud	Conexión cuadro
CN450N1/4A	€ 27,30	150 mm	1/4"
CN450N3/8A	€ 31,60	205 mm	3/8"
CN450N1/2A	€ 32,70	250 mm	1/2"

**0439-**

**CARRACA ERGONOMICA**

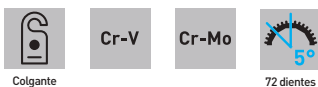

Art.	€	Conexión cuadro	Longitud	Dientes
0439/1/4	€ 18,70	1/4"	155 mm	72
0439/3/8	€ 26,40	3/8"	200 mm	72
0439/1/2	€ 31,60	1/2"	260 mm	72

**0173**

€ 5,00

**MANGO RECTO PARA LLAVES DE VASO CON CUADRADILLO DE 1/4"**

Mango recto para llaves de vaso con cuadradillo de 1/4".

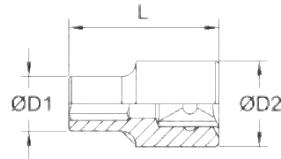

**BN4E5NX**
**LLAVE DE VASO DE 6 CARAS, SERIE NORMAL**

Art.	€	Medida	D1	D2	Longitud
BN4E5N004A	€ 1,56	4 mm	6,8 mm	12 mm	25 mm
BN4E5N0045A	€ 1,56	4,5 mm	7,2 mm	12 mm	25 mm
BN4E5N005A	€ 1,56	5 mm	7,8 mm	12 mm	25 mm
BN4E5N0055A	€ 1,56	5,5 mm	8,4 mm	12 mm	25 mm
BN4E5N006A	€ 1,56	6 mm	9,3 mm	12 mm	25 mm
BN4E5N007A	€ 1,56	7 mm	10,8 mm	12 mm	25 mm
BN4E5N008A	€ 1,81	8 mm	12 mm	11 mm	25 mm
BN4E5N009A	€ 1,81	9 mm	13 mm	12 mm	25 mm
BN4E5N010A	€ 1,81	10 mm	14,6 mm	12 mm	25 mm
BN4E5N011A	€ 2,03	11 mm	16 mm	12,5 mm	25 mm
BN4E5N012A	€ 2,03	12 mm	17 mm	13,5 mm	25 mm
BN4E5N013A	€ 2,24	13 mm	18 mm	13,5 mm	25 mm
BN4E5N014A	€ 2,47	14 mm	19 mm	14,5 mm	25 mm

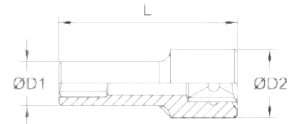
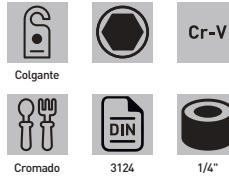
**BN4E5LX**
**LLAVE DE VASO LARGA DE 6 CARAS**

Art.	€	Medida	D1	D2	Longitud
BN4E5L004A	€ 3,71	4 mm	6,8 mm	12 mm	50 mm
BN4E5L0045A	€ 3,71	4,5 mm	7,2 mm	12 mm	50 mm
BN4E5L005A	€ 3,71	5 mm	7,8 mm	12 mm	50 mm
BN4E5L0055A	€ 3,71	5,5 mm	8,4 mm	12 mm	50 mm
BN4E5L006A	€ 3,71	6 mm	9,3 mm	12 mm	50 mm
BN4E5L007A	€ 3,71	7 mm	10,8 mm	12 mm	50 mm
BN4E5L008A	€ 3,71	8 mm	12 mm	11 mm	50 mm
BN4E5L009A	€ 3,71	9 mm	13 mm	12 mm	50 mm
BN4E5L010A	€ 3,71	10 mm	14,6 mm	12 mm	50 mm
BN4E5L011A	€ 4,03	11 mm	16 mm	13 mm	50 mm
BN4E5L012A	€ 4,03	12 mm	17 mm	13 mm	50 mm
BN4E5L013A	€ 4,25	13 mm	18 mm	13 mm	50 mm
BN4E5L014A	€ 4,25	14 mm	19 mm	14,5 mm	50 mm

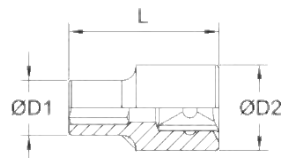
**BN4P5NX**
**LLAVE DE VASO DE 12 CARAS, SERIE NORMAL**

Art.	€	Medida	D1	D2	Longitud
BN4P5N004A	€ 1,48	4 mm	6,8 mm	12 mm	25 mm
BN4P5N005A	€ 1,48	5 mm	7,8 mm	12 mm	25 mm
BN4P5N0055A	€ 1,48	5,5 mm	8,4 mm	12 mm	25 mm
BN4P5N006A	€ 1,48	6 mm	9,3 mm	12 mm	25 mm
BN4P5N007A	€ 1,48	7 mm	10,8 mm	12 mm	25 mm
BN4P5N008A	€ 1,68	8 mm	12 mm	11 mm	25 mm
BN4P5N009A	€ 1,68	9 mm	13 mm	12 mm	25 mm
BN4P5N010A	€ 1,68	10 mm	14,6 mm	12 mm	25 mm
BN4P5N011A	€ 1,91	11 mm	16 mm	12,5 mm	25 mm
BN4P5N012A	€ 1,91	12 mm	17 mm	13,5 mm	25 mm
BN4P5N013A	€ 2,14	13 mm	18 mm	13,5 mm	25 mm
BN4P5N014A	€ 2,24	14 mm	19 mm	14,5 mm	25 mm

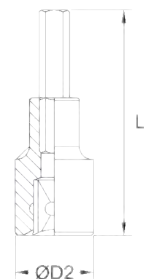
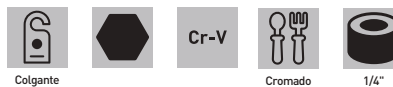
**BN415NX**
**LLAVE DE VASO CON INSERTO HEX**

Art.	€	Medida	D2	Longitud
BN415N003A	€ 2,81	3 mm	12 mm	37 mm
BN415N004A	€ 2,81	4 mm	12 mm	37 mm
BN415N005A	€ 2,81	5 mm	12 mm	37 mm
BN415N006A	€ 2,81	6 mm	12 mm	37 mm
BN415N008A	€ 2,81	8 mm	12 mm	37 mm



**BN425NX**

**LLAVE DE VASO CON INSERTO TORX**

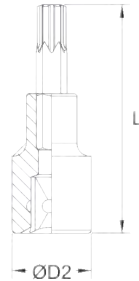

Art.	€	Medida	D2	Longitud
BN425N008A	€ 2,81	T8	12 mm	37 mm
BN425N009A	€ 2,81	T9	12 mm	37 mm
BN425N010A	€ 2,81	T10	12 mm	37 mm
BN425N015A	€ 2,81	T15	12 mm	37 mm
BN425N020A	€ 2,81	T20	12 mm	37 mm
BN425N025A	€ 2,81	T25	12 mm	37 mm
BN425N027A	€ 2,81	T27	12 mm	37 mm
BN425N030A	€ 2,81	T30	12 mm	37 mm
BN425N040A	€ 2,81	T40	12 mm	37 mm

**BN445NX**

**LLAVE DE VASO CON INSERTO XZN**

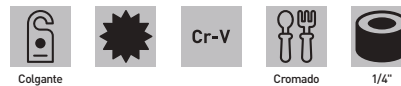
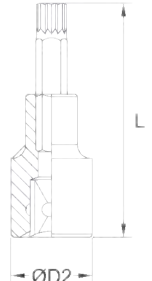

Art.	€	Medida	D2	Longitud
BN445N004A	€ 9,50	M 4	15 mm	37 mm
BN445N005A	€ 9,50	M 5	15 mm	37 mm
BN445N006A	€ 9,50	M 6	15 mm	37 mm
BN445N008A	€ 9,50	M 8	15 mm	37 mm
BN445N009A	€ 9,50	M 9	15 mm	37 mm
BN445N010A	€ 9,50	M 10	15 mm	37 mm

**RN4054NA**

€ 3,36

**AMPLIADOR**



Longitud 26 mm

**JN405NA**

€ 6,10

**ARTICULACION UNIVERSAL**



Longitud 38 mm

**PN405NX**

**ALARGADERA**

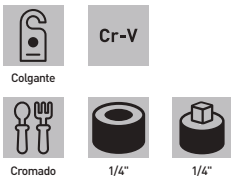

Art.	€	Longitud
PN405N050A	€ 3,36	50 mm
PN405N075A	€ 3,59	75 mm
PN405N150A	€ 5,40	150 mm

**EN405NX**

**ALARGADERA ANGULAR**

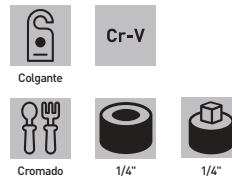

Art.	€	Longitud
EN405N050A	€ 4,46	50 mm
EN405N075A	€ 5,10	75 mm
EN405N150A	€ 5,60	150 mm

**LN400N1/4A**

€ 5,10

**MANGO CORREDIZO**



Longitud 115 mm

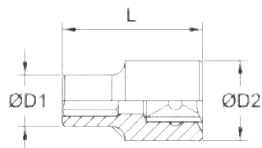
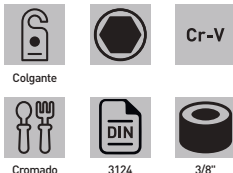

**BN4E4NX**
**LLAVE DE VASO DE 6 CARAS, SERIE NORMAL**

Art.	€	Medida	D1	D2	Longitud
BN4E4N006A	€ 2,69	6 mm	9,3 mm	17 mm	28 mm
BN4E4N007A	€ 2,69	7 mm	10,6 mm	17 mm	28 mm
BN4E4N008A	€ 2,69	8 mm	11,8 mm	17 mm	28 mm
BN4E4N009A	€ 2,69	9 mm	13,2 mm	17 mm	28 mm
BN4E4N010A	€ 2,69	10 mm	14,5 mm	17 mm	28 mm
BN4E4N011A	€ 2,69	11 mm	15,7 mm	17 mm	28 mm
BN4E4N012A	€ 2,69	12 mm	17 mm	16,4 mm	28 mm
BN4E4N013A	€ 2,69	13 mm	18 mm	17 mm	28 mm
BN4E4N014A	€ 3,36	14 mm	20 mm	17 mm	28 mm
BN4E4N015A	€ 3,36	15 mm	20,9 mm	18 mm	28 mm
BN4E4N016A	€ 3,36	16 mm	22 mm	18 mm	28 mm
BN4E4N017A	€ 3,36	17 mm	24 mm	18 mm	30 mm
BN4E4N018A	€ 4,03	18 mm	26 mm	18 mm	30 mm
BN4E4N019A	€ 4,25	19 mm	26 mm	20 mm	30 mm
BN4E4N020A	€ 5,00	20 mm	27,1 mm	20 mm	30 mm
BN4E4N021A	€ 5,00	21 mm	28 mm	20 mm	30 mm
BN4E4N022A	€ 5,90	22 mm	30 mm	20 mm	32 mm

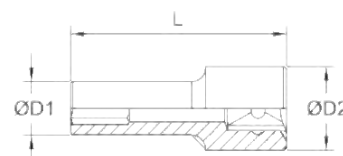
**BN4E4LX**
**LLAVE DE VASO LARGA DE 6 CARAS**

Art.	€	Medida	D1	D2	Longitud
BN4E4L006A	€ 5,90	6 mm	9,3 mm	17 mm	63 mm
BN4E4L007A	€ 5,90	7 mm	10,6 mm	17 mm	62 mm
BN4E4L008A	€ 5,90	8 mm	11,8 mm	17 mm	63 mm
BN4E4L009A	€ 5,90	9 mm	13,2 mm	17 mm	63 mm
BN4E4L010A	€ 5,90	10 mm	14,5 mm	17 mm	63 mm
BN4E4L011A	€ 5,90	11 mm	15,7 mm	17 mm	63 mm
BN4E4L012A	€ 5,90	12 mm	17 mm	16,4 mm	63 mm
BN4E4L013A	€ 5,90	13 mm	18 mm	17 mm	63 mm
BN4E4L014A	€ 6,60	14 mm	19,6 mm	17 mm	63 mm
BN4E4L015A	€ 6,60	15 mm	20,9 mm	18 mm	63 mm
BN4E4L016A	€ 6,60	16 mm	22 mm	18 mm	63 mm
BN4E4L017A	€ 6,60	17 mm	23,4 mm	18 mm	63 mm
BN4E4L018A	€ 7,70	18 mm	24,6 mm	20 mm	63 mm
BN4E4L019A	€ 7,70	19 mm	26 mm	20 mm	63 mm
BN4E4L020A	€ 7,70	20 mm	27,1 mm	20 mm	63 mm
BN4E4L021A	€ 9,00	21 mm	28 mm	20 mm	63 mm
BN4E4L022A	€ 9,00	22 mm	30 mm	20 mm	63 mm

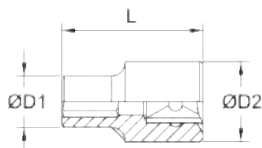
**BN4P4NX**
**LLAVE DE VASO DE 12 CARAS, SERIE NORMAL**

Art.	€	Medida	D1	D2	Longitud
BN4P4N006A	€ 2,47	6 mm	9,3 mm	17 mm	28 mm
BN4P4N007A	€ 2,47	7 mm	10,6 mm	17 mm	28 mm
BN4P4N008A	€ 2,47	8 mm	11,8 mm	17 mm	28 mm
BN4P4N009A	€ 2,47	9 mm	13,2 mm	17 mm	28 mm
BN4P4N010A	€ 2,47	10 mm	14,5 mm	17 mm	28 mm
BN4P4N011A	€ 2,47	11 mm	15,7 mm	17 mm	28 mm
BN4P4N012A	€ 2,47	12 mm	17 mm	16,4 mm	28 mm
BN4P4N013A	€ 2,47	13 mm	18 mm	17 mm	28 mm
BN4P4N014A	€ 3,14	14 mm	20 mm	17 mm	28 mm
BN4P4N015A	€ 3,14	15 mm	20,9 mm	18 mm	28 mm
BN4P4N016A	€ 3,14	16 mm	22 mm	18 mm	28 mm
BN4P4N017A	€ 3,14	17 mm	24 mm	18 mm	30 mm
BN4P4N018A	€ 3,80	18 mm	26 mm	18 mm	30 mm
BN4P4N019A	€ 4,03	19 mm	26 mm	20 mm	30 mm
BN4P4N020A	€ 4,58	20 mm	28 mm	20 mm	30 mm
BN4P4N021A	€ 4,58	21 mm	28 mm	20 mm	30 mm
BN4P4N022A	€ 5,50	22 mm	30 mm	20 mm	32 mm





**BN414NX**

**LLAVE DE VASO CON INSERTO HEX**

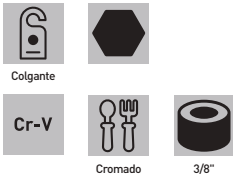

Art.	€	Medida	D2	Longitud
BN414N003A	€ 6,40	3 mm	18 mm	48 mm
BN414N004A	€ 6,40	4 mm	18 mm	48 mm
BN414N005A	€ 6,40	5 mm	18 mm	48 mm
BN414N006A	€ 6,40	6 mm	18 mm	48 mm
BN414N007A	€ 6,40	7 mm	18 mm	48 mm
BN414N008A	€ 6,40	8 mm	18 mm	48 mm
BN414N009A	€ 6,40	9 mm	20 mm	48 mm
BN414N010A	€ 6,40	10 mm	20 mm	48 mm
BN414N012A	€ 6,50	12 mm	20 mm	48 mm

**BN414LX**

**LLAVE DE VASO CON INSERTO HEX LARGO**

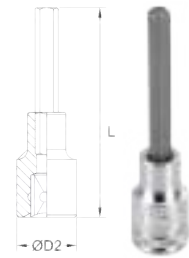

Art.	€	Medida	D2	Longitud
BN414L003A	€ 9,20	3 mm	18 mm	95 mm
BN414L004A	€ 9,20	4 mm	18 mm	95 mm
BN414L005A	€ 9,20	5 mm	18 mm	95 mm
BN414L006A	€ 9,20	6 mm	18 mm	95 mm
BN414L007A	€ 9,50	7 mm	18 mm	95 mm
BN414L008A	€ 9,50	8 mm	18 mm	95 mm
BN414L009A	€ 9,50	9 mm	20 mm	95 mm
BN414L010A	€ 9,50	10 mm	20 mm	95 mm
BN414L012A	€ 10,70	12 mm	20 mm	95 mm

**BN424NX**

**LLAVE DE VASO CON INSERTO TORX**

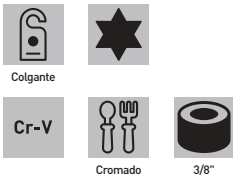

Art.	€	Medida	D2	Longitud
BN424N010A	€ 6,80	T10	18 mm	48 mm
BN424N015A	€ 6,80	T15	18 mm	48 mm
BN424N020A	€ 6,80	T20	18 mm	48 mm
BN424N025A	€ 6,80	T25	18 mm	48 mm
BN424N027A	€ 6,80	T27	18 mm	48 mm
BN424N030A	€ 6,80	T30	18 mm	48 mm
BN424N040A	€ 6,80	T40	18 mm	48 mm
BN424N045A	€ 6,80	T45	18 mm	48 mm
BN424N050A	€ 7,70	T50	20 mm	48 mm
BN424N055A	€ 9,00	T55	20 mm	48 mm

**BN424LX**

**LLAVE DE VASO CON INSERTO TORX LARGO**

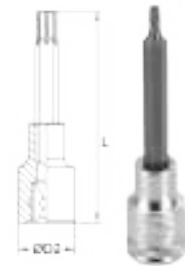

Art.	€	Medida	D2	Longitud
BN424L015A	€ 11,20	T15	18 mm	95 mm
BN424L020A	€ 11,20	T20	18 mm	95 mm
BN424L025A	€ 11,20	T25	18 mm	95 mm
BN424L027A	€ 11,20	T27	18 mm	95 mm
BN424L030A	€ 11,20	T30	18 mm	95 mm
BN424L040A	€ 11,20	T40	18 mm	95 mm
BN424L045A	€ 15,00	T45	18 mm	95 mm

**BN434NX**

**LLAVE DE VASO CON INSERTO RIBE**

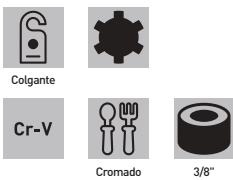

Art.	€	Medida	D2	Longitud
BN434N004A	€ 14,40	M 4	18 mm	50 mm
BN434N005A	€ 14,60	M 5	18 mm	50 mm
BN434N006A	€ 14,90	M 6	18 mm	50 mm
BN434N007A	€ 15,10	M 7	18 mm	50 mm
BN434N008A	€ 15,40	M 8	18 mm	50 mm
BN434N009A	€ 16,10	M 9	18 mm	50 mm
BN434N010A	€ 17,50	M 10	20 mm	50 mm

**BN434LX**

**LLAVE DE VASO CON INSERTO RIBE LARGO**

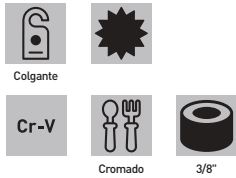

Art.	€	Medida	D2	Longitud
BN434L004A	€ 15,40	M 4	18 mm	95 mm
BN434L005A	€ 15,60	M 5	18 mm	95 mm
BN434L006A	€ 16,00	M 6	18 mm	95 mm
BN434L007A	€ 16,00	M 7	18 mm	95 mm
BN434L008A	€ 16,80	M 8	18 mm	95 mm
BN434L009A	€ 16,80	M 9	18 mm	95 mm
BN434L010A	€ 20,70	M 10	20 mm	95 mm

**BN444NX**
**LLAVE DE VASO CON INSERTO XZN**

Art.	€	Medida	D2	Longitud
BN444N004A	€ 11,20	M 4	18 mm	48 mm
BN444N005A	€ 11,20	M 5	18 mm	48 mm
BN444N006A	€ 11,20	M 6	18 mm	48 mm
BN444N008A	€ 11,20	M 8	18 mm	48 mm
BN444N009A	€ 11,20	M 9	20 mm	48 mm
BN444N010A	€ 11,20	M 10	20 mm	48 mm
BN444N012A	€ 11,90	M 12	20 mm	48 mm
BN444N014A	€ 12,70	M 14	20 mm	48 mm

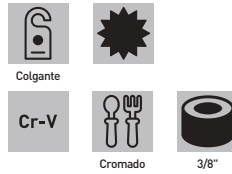
**BN444LX**
**LLAVE DE VASO CON INSERTO XZN LARGO**

Art.	€	Medida	D2	Longitud
BN444L004A	€ 12,30	M 4	18 mm	95 mm
BN444L005A	€ 12,30	M 5	18 mm	95 mm
BN444L006A	€ 12,30	M 6	18 mm	95 mm
BN444L008A	€ 12,30	M 8	18 mm	95 mm
BN444L009A	€ 12,30	M 9	20 mm	95 mm
BN444L010A	€ 12,70	M 10	20 mm	95 mm
BN444L012A	€ 13,50	M 12	20 mm	95 mm
BN444L014A	€ 14,50	M 14	20 mm	95 mm

**BN4C4LX**
**LLAVE DE VASO PARA BUJIAS**

Art.	€	Medida	Longitud
BN4C4L016A	€ 5,60	16 mm	63 mm
BN4C4L018A	€ 7,90	18 mm	63 mm
BN4C4L021A	€ 8,50	21 mm	65 mm

**LN400N3/8A**
**€ 9,80**
**MANGO CORREDIZO**

Longitud	200 mm
----------	--------

**RN4045NA**
**€ 3,36**
**REDUCTOR**



Longitud	27 mm
----------	-------

**RN4043NA**
**€ 3,92**
**AMPLIADOR**

Longitud	35 mm
----------	-------

**JN404NA**
**€ 7,70**
**ARTICULACION UNIVERSAL**

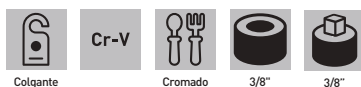
Longitud	54 mm
----------	-------

**PN404NX**
**ALARGADERA**

Art.	€	Longitud
PN404N050A	€ 3,80	50 mm
PN404N075A	€ 5,20	75 mm
PN404N150A	€ 6,30	150 mm

**EN404NX**
**ALARGADERA ANGULAR**

Art.	€	Longitud
EN404N038A	€ 4,46	38 mm
EN404N075A	€ 5,60	75 mm
EN404N150A	€ 6,80	150 mm
EN404N250A	€ 11,00	250 mm



**BN4E3NX**

**LLAVE DE VASO DE 6 CARAS, SERIE NORMAL**

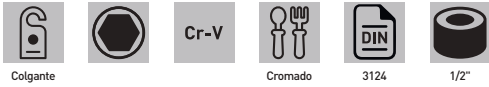
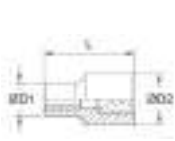

Art.	€	Medida	D1	D2	Longitud
BN4E3N008A	€ 3,36	8 mm	12,2 mm	22 mm	38 mm
BN4E3N009A	€ 3,36	9 mm	13,5 mm	22 mm	38 mm
BN4E3N010A	€ 3,36	10 mm	15 mm	22 mm	38 mm
BN4E3N011A	€ 3,36	11 mm	16,3 mm	22 mm	38 mm
BN4E3N012A	€ 3,36	12 mm	17,6 mm	22 mm	38 mm
BN4E3N013A	€ 3,36	13 mm	18,8 mm	22 mm	38 mm
BN4E3N014A	€ 3,36	14 mm	20,4 mm	22 mm	38 mm
BN4E3N015A	€ 3,48	15 mm	21 mm	22 mm	38 mm
BN4E3N016A	€ 3,77	16 mm	22 mm	20,5 mm	38 mm
BN4E3N017A	€ 4,03	17 mm	24 mm	22 mm	38 mm
BN4E3N018A	€ 4,37	18 mm	25,4 mm	22 mm	38 mm
BN4E3N019A	€ 4,37	19 mm	26 mm	22 mm	38 mm
BN4E3N020A	€ 4,66	20 mm	28 mm	22 mm	38 mm
BN4E3N021A	€ 4,88	21 mm	28 mm	22 mm	38 mm
BN4E3N022A	€ 5,50	22 mm	30 mm	26 mm	38 mm
BN4E3N023A	€ 5,60	23 mm	31,6 mm	26 mm	38 mm
BN4E3N024A	€ 5,60	24 mm	32 mm	26 mm	38 mm
BN4E3N025A	€ 6,20	25 mm	34 mm	26 mm	42 mm
BN4E3N026A	€ 6,30	26 mm	35,4 mm	28 mm	42 mm
BN4E3N027A	€ 6,30	27 mm	36 mm	28 mm	42 mm
BN4E3N028A	€ 6,60	28 mm	38 mm	28 mm	42 mm
BN4E3N029A	€ 6,90	29 mm	38 mm	28 mm	43 mm
BN4E3N030A	€ 6,90	30 mm	40 mm	28 mm	43 mm
BN4E3N032A	€ 6,90	32 mm	42 mm	28 mm	44 mm

**BN4E3LX**

**LLAVE DE VASO LARGA DE 6 CARAS**

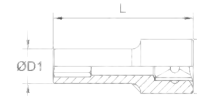
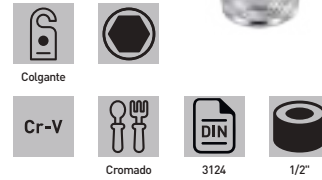

Art.	€	Medida	D1	D2	Longitud
BN4E3L010A	€ 7,40	10 mm	15 mm	22 mm	77 mm
BN4E3L011A	€ 7,40	11 mm	16,3 mm	22 mm	77 mm
BN4E3L012A	€ 7,40	12 mm	17,6 mm	22 mm	77 mm
BN4E3L013A	€ 7,40	13 mm	18,8 mm	22 mm	77 mm
BN4E3L014A	€ 7,70	14 mm	20,4 mm	22 mm	77 mm
BN4E3L015A	€ 7,70	15 mm	21 mm	22 mm	77 mm
BN4E3L016A	€ 7,70	16 mm	22 mm	20,5 mm	77 mm
BN4E3L017A	€ 7,90	17 mm	24 mm	22 mm	77 mm
BN4E3L018A	€ 8,50	18 mm	25,4 mm	22 mm	77 mm
BN4E3L019A	€ 8,50	19 mm	26 mm	22 mm	77 mm
BN4E3L020A	€ 8,90	20 mm	28 mm	22 mm	77 mm
BN4E3L021A	€ 9,20	21 mm	28 mm	22 mm	77 mm
BN4E3L022A	€ 9,20	22 mm	30 mm	26 mm	77 mm
BN4E3L023A	€ 11,10	23 mm	31,6 mm	26 mm	77 mm
BN4E3L024A	€ 11,70	24 mm	32 mm	26 mm	77 mm
BN4E3L027A	€ 16,30	27 mm	36 mm	28 mm	77 mm
BN4E3L030A	€ 17,60	30 mm	40 mm	28 mm	77 mm
BN4E3L032A	€ 17,60	32 mm	42 mm	28 mm	77 mm

**BN4P3NX**

**LLAVE DE VASO DE 12 CARAS, SERIE NORMAL**

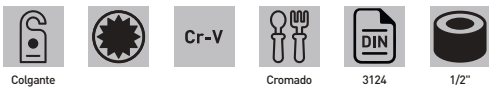
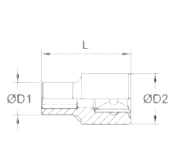

Art.	€	Medida	D1	D2	Longitud
BN4P3N008A	€ 3,14	8 mm	12,2 mm	22 mm	38 mm
BN4P3N009A	€ 3,14	9 mm	13,5 mm	22 mm	38 mm
BN4P3N010A	€ 3,14	10 mm	15 mm	22 mm	38 mm
BN4P3N011A	€ 3,14	11 mm	16,3 mm	22 mm	38 mm
BN4P3N012A	€ 3,14	12 mm	17,6 mm	22 mm	38 mm
BN4P3N013A	€ 3,14	13 mm	18,8 mm	22 mm	38 mm
BN4P3N014A	€ 3,14	14 mm	20,4 mm	22 mm	38 mm
BN4P3N015A	€ 3,26	15 mm	21 mm	22 mm	38 mm
BN4P3N016A	€ 3,48	16 mm	22 mm	20,5 mm	38 mm
BN4P3N017A	€ 3,80	17 mm	24 mm	22 mm	38 mm
BN4P3N018A	€ 4,14	18 mm	25,4 mm	22 mm	38 mm
BN4P3N019A	€ 4,14	19 mm	26 mm	22 mm	38 mm
BN4P3N020A	€ 4,37	20 mm	28 mm	22 mm	38 mm
BN4P3N021A	€ 4,58	21 mm	28 mm	22 mm	38 mm
BN4P3N022A	€ 5,20	22 mm	30 mm	26 mm	38 mm
BN4P3N023A	€ 5,30	23 mm	31,6 mm	26 mm	38 mm
BN4P3N024A	€ 5,30	24 mm	32 mm	26 mm	38 mm
BN4P3N025A	€ 6,20	25 mm	34 mm	26 mm	42 mm
BN4P3N026A	€ 6,30	26 mm	35,4 mm	28 mm	42 mm
BN4P3N027A	€ 6,30	27 mm	36 mm	28 mm	42 mm
BN4P3N028A	€ 6,60	28 mm	38 mm	28 mm	43 mm
BN4P3N029A	€ 6,90	29 mm	38 mm	28 mm	43 mm
BN4P3N030A	€ 6,90	30 mm	40 mm	28 mm	43 mm
BN4P3N032A	€ 6,90	32 mm	42 mm	28 mm	44 mm

**BN4P3LX**

**LLAVE DE VASO LARGA DE 12 CARAS**

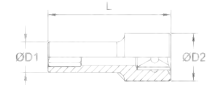

Art.	€	Medida	D1	D2	Longitud
BN4P3L010A	€ 6,90	10 mm	15 mm	22 mm	77 mm
BN4P3L011A	€ 6,90	11 mm	16,3 mm	22 mm	77 mm
BN4P3L012A	€ 6,90	12 mm	17,6 mm	22 mm	77 mm
BN4P3L013A	€ 6,90	13 mm	18,8 mm	22 mm	77 mm
BN4P3L014A	€ 7,10	14 mm	20,4 mm	22 mm	77 mm
BN4P3L015A	€ 7,10	15 mm	21 mm	22 mm	77 mm
BN4P3L016A	€ 7,10	16 mm	22 mm	20,5 mm	77 mm
BN4P3L017A	€ 7,50	17 mm	24 mm	22 mm	77 mm
BN4P3L018A	€ 8,00	18 mm	25,4 mm	22 mm	77 mm
BN4P3L019A	€ 8,00	19 mm	26 mm	22 mm	77 mm
BN4P3L020A	€ 8,40	20 mm	28 mm	22 mm	77 mm
BN4P3L021A	€ 8,70	21 mm	28 mm	22 mm	77 mm
BN4P3L022A	€ 9,20	22 mm	30 mm	26 mm	77 mm
BN4P3L023A	€ 11,10	23 mm	31,6 mm	26 mm	77 mm
BN4P3L024A	€ 11,10	24 mm	32 mm	26 mm	77 mm
BN4P3L027A	€ 16,30	27 mm	36 mm	28 mm	77 mm
BN4P3L030A	€ 17,60	30 mm	40 mm	28 mm	77 mm
BN4P3L032A	€ 17,60	32 mm	42 mm	28 mm	77 mm

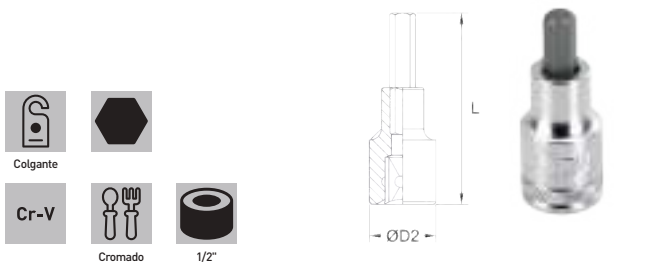
**BN413NX**
**LLAVE DE VASO CON INSERTO HEX**

Art.	€	Medida	D2	Longitud
BN413N004A	€ 6,40	4 mm	22 mm	55 mm
BN413N005A	€ 6,40	5 mm	22 mm	55 mm
BN413N006A	€ 6,40	6 mm	22 mm	55 mm
BN413N007A	€ 7,00	7 mm	22 mm	55 mm
BN413N008A	€ 7,00	8 mm	22 mm	55 mm
BN413N010A	€ 7,00	10 mm	22 mm	55 mm
BN413N012A	€ 7,00	12 mm	22 mm	55 mm
BN413N014A	€ 8,40	14 mm	24 mm	55 mm
BN413N017A	€ 9,00	17 mm	26 mm	55 mm
BN413N019A	€ 9,00	19 mm	28 mm	55 mm

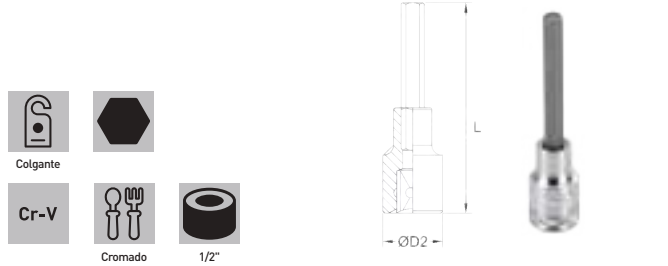
**BN413LX**
**LLAVE DE VASO CON INSERTO HEX LARGO**

Art.	€	Medida	D2	Longitud
BN413L004A	€ 8,40	4 mm	22 mm	100 mm
BN413L005A	€ 8,40	5 mm	22 mm	100 mm
BN413L006A	€ 8,40	6 mm	22 mm	100 mm
BN413L007A	€ 8,40	7 mm	22 mm	100 mm
BN413L008A	€ 8,40	8 mm	22 mm	100 mm
BN413L010A	€ 8,40	10 mm	22 mm	100 mm
BN413L012A	€ 8,50	12 mm	22 mm	100 mm
BN413L014A	€ 8,50	14 mm	24 mm	100 mm
BN413L017A	€ 12,30	17 mm	26 mm	100 mm
BN413L019A	€ 13,20	19 mm	28 mm	100 mm

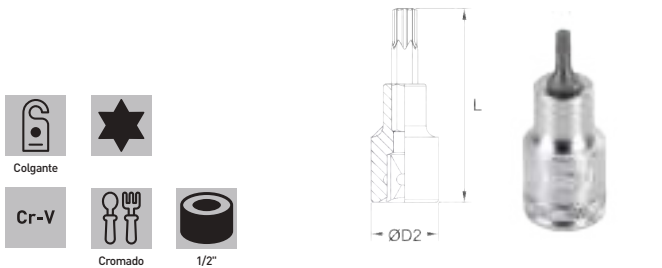
**BN423NX**
**LLAVE DE VASO CON INSERTO TORX**

Art.	€	Medida	D2	Longitud
BN423N020A	€ 8,00	T20	22 mm	55 mm
BN423N025A	€ 8,00	T25	22 mm	55 mm
BN423N027A	€ 8,00	T27	22 mm	55 mm
BN423N030A	€ 8,00	T30	22 mm	55 mm
BN423N040A	€ 8,60	T40	22 mm	55 mm
BN423N045A	€ 8,60	T45	22 mm	55 mm
BN423N050A	€ 8,60	T50	22 mm	55 mm
BN423N055A	€ 9,70	T55	22 mm	55 mm
BN423N060A	€ 10,20	T60	22 mm	55 mm
BN423N070A	€ 12,50	T70	22 mm	55 mm

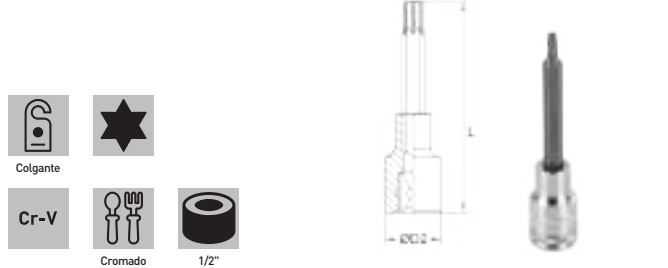
**BN423LX**
**LLAVE DE VASO CON INSERTO TORX LARGO**

Art.	€	Medida	D2	Longitud
BN423L020A	€ 9,00	T20	22 mm	100 mm
BN423L025A	€ 9,00	T25	22 mm	100 mm
BN423L027A	€ 9,00	T27	22 mm	100 mm
BN423L030A	€ 9,00	T30	22 mm	100 mm
BN423L040A	€ 9,50	T40	22 mm	100 mm
BN423L045A	€ 9,50	T45	22 mm	100 mm
BN423L050A	€ 9,50	T50	22 mm	100 mm
BN423L055A	€ 11,20	T55	22 mm	100 mm
BN423L060A	€ 11,20	T60	22 mm	100 mm
BN423L070A	€ 15,10	T70	22 mm	100 mm

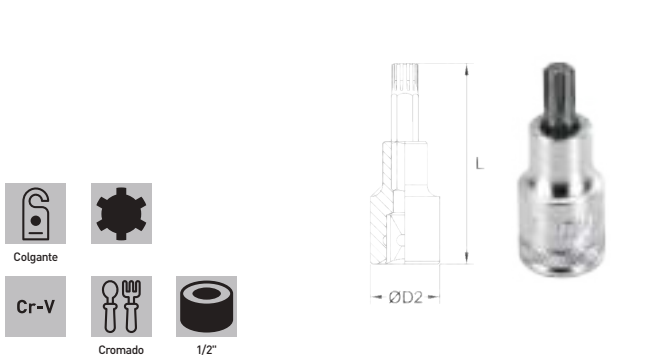
**BN433NX**
**LLAVE DE VASO CON INSERTO RIBE**

Art.	€	Medida	D2	Longitud
BN433N008A	€ 8,60	M 8	22 mm	55 mm
BN433N009A	€ 8,60	M 9	22 mm	55 mm
BN433N010A	€ 8,60	M 10	22 mm	55 mm
BN433N012A	€ 9,50	M 12	22 mm	55 mm
BN433N013A	€ 10,10	M 13	24 mm	55 mm
BN433N014A	€ 10,10	M 14	24 mm	55 mm

**BN433LX**
**LLAVE DE VASO CON INSERTO RIBE LARGO**

Art.	€	Medida	D2	Longitud
BN433L008A	€ 10,70	M 8	24 mm	100 mm
BN433L009A	€ 10,70	M 9	24 mm	100 mm
BN433L010A	€ 10,70	M 10	24 mm	100 mm
BN433L012A	€ 11,70	M 12	24 mm	100 mm
BN433L013A	€ 11,70	M 13	24 mm	100 mm
BN433L014A	€ 13,50	M 14	24 mm	100 mm



**BN443NX**

**LLAVE DE VASO CON INSERTO XZN**



Cr-V



Cromado



1/2"

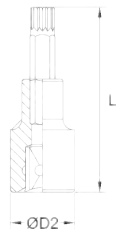

Art.	€	Medida	D2	Longitud
BN443N005A	€ 9,00	M 5	22 mm	55 mm
BN443N006A	€ 9,00	M 6	22 mm	55 mm
BN443N008A	€ 9,00	M 8	22 mm	55 mm
BN443N009A	€ 9,00	M 9	22 mm	55 mm
BN443N010A	€ 9,00	M 10	22 mm	55 mm
BN443N012A	€ 10,20	M 12	22 mm	55 mm
BN443N014A	€ 10,20	M 14	24 mm	55 mm
BN443N016A	€ 10,30	M 16	24 mm	55 mm

**BN443LX**

**LLAVE DE VASO CON INSERTO XZN LARGO**



Cr-V



Cromado



1/2"

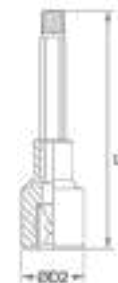

Art.	€	Medida	D2	Longitud
BN443L005A	€ 10,30	M 5	22 mm	100 mm
BN443L006A	€ 10,30	M 6	22 mm	100 mm
BN443L008A	€ 10,30	M 8	22 mm	100 mm
BN443L009A	€ 10,80	M 9	22 mm	100 mm
BN443L010A	€ 10,80	M 10	22 mm	100 mm
BN443L012A	€ 11,30	M 12	22 mm	100 mm
BN443L014A	€ 12,00	M 14	24 mm	100 mm
BN443L016A	€ 12,40	M 16	24 mm	100 mm

**BN4C3LX**

**LLAVE DE VASO PARA BUJIAS**



Cr-V



Cromado



1/2"



Art.	€	Medida	Longitud
BN4C3L016A	€ 5,20	16 mm	65 mm
BN4C3L018A	€ 6,10	18 mm	65 mm
BN4C3L021A	€ 7,40	21 mm	65 mm

**PN403NX**

**ALARGADERA**



Cr-V



Cromado



1/2"



Art.	€	Longitud
PN403N050A	€ 5,40	50 mm
PN403N075A	€ 6,80	75 mm
PN403N150A	€ 9,60	150 mm
PN403N250A	€ 11,80	250 mm

**EN403NX**

**ALARGADERA ANGULAR**



Cr-V



Cromado



1/2"



1/2"

Art.	€	Longitud
EN403N050A	€ 6,30	50 mm
EN403N075A	€ 6,80	75 mm
EN403N125A	€ 9,60	125 mm
EN403N250A	€ 16,30	250 mm
EN403N500A	€ 27,30	500 mm

**LN400N1/2A**

€ 13,20

**MANGO CORREDIZO**



Cr-V



1/2"

Longitud	300 mm
----------	--------

**RN4034NA**

€ 3,92

**REDUCTOR**

Con cuadradillo hembra 1/2" y macho 3/8"



Cr-V



1/2"



3/8"



Longitud	36 mm
----------	-------

**RN4032NA**

€ 9,00

**AMPLIADOR**



Cr-V



1/2"



3/4"



Longitud	46 mm
----------	-------

**JN403NA**

€ 11,10

**ARTICULACION UNIVERSAL**



Cr-V



1/2"



1/2"



Longitud	75 mm
----------	-------

**BN4E2NX**
**LLAVE DE VASO DE 6 CARAS, SERIE NORMAL**



Colgante



Cromado

3124

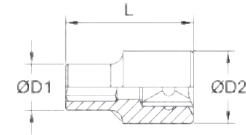
3/4"



Art.	€	Medida	D1	D2	Longitud
BN4E2N019	€ 8,50	19 mm	30 mm	36 mm	50 mm
BN4E2N020	€ 8,50	20 mm	31 mm	36 mm	50 mm
BN4E2N021	€ 8,50	21 mm	32 mm	36 mm	50 mm
BN4E2N022	€ 8,50	22 mm	33 mm	36 mm	50 mm
BN4E2N023	€ 8,50	23 mm	34 mm	36 mm	50 mm
BN4E2N024	€ 8,50	24 mm	35 mm	36 mm	50 mm
BN4E2N025	€ 8,50	25 mm	36 mm	35 mm	52 mm
BN4E2N026	€ 8,50	26 mm	37 mm	36 mm	52 mm
BN4E2N027	€ 10,10	27 mm	38 mm	36 mm	52 mm
BN4E2N028	€ 10,10	28 mm	39 mm	38 mm	52 mm
BN4E2N029	€ 10,10	29 mm	40 mm	38 mm	52 mm
BN4E2N030	€ 10,10	30 mm	42 mm	38 mm	54 mm
BN4E2N032	€ 10,10	32 mm	43 mm	38 mm	56 mm
BN4E2N033	€ 10,70	33 mm	44 mm	38 mm	56 mm
BN4E2N034	€ 10,70	34 mm	46 mm	38 mm	56 mm
BN4E2N035	€ 11,00	35 mm	47 mm	42 mm	56 mm
BN4E2N036	€ 11,00	36 mm	48 mm	42 mm	58 mm
BN4E2N038	€ 13,20	38 mm	50 mm	42 mm	58 mm
BN4E2N041	€ 14,90	41 mm	52 mm	45 mm	60 mm
BN4E2N046	€ 16,50	46 mm	56 mm	45 mm	64 mm
BN4E2N050	€ 19,80	50 mm	62 mm	48 mm	68 mm
BN4E2N055	€ 24,20	55 mm	68 mm	48 mm	72 mm
BN4E2N060	€ 30,00	60 mm	74 mm	48 mm	76 mm

**BN4P2NX**
**LLAVE DE VASO DE 12 CARAS, SERIE NORMAL**



Colgante



Cromado

3124

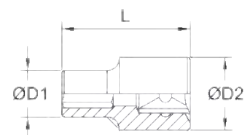
3/4"



Art.	€	Medida	D1	D2	Longitud
BN4P2N019	€ 7,90	19 mm	30 mm	36 mm	50 mm
BN4P2N020	€ 7,90	20 mm	31 mm	36 mm	50 mm
BN4P2N021	€ 7,90	21 mm	32 mm	36 mm	50 mm
BN4P2N022	€ 7,90	22 mm	33 mm	36 mm	50 mm
BN4P2N023	€ 7,90	23 mm	34 mm	36 mm	50 mm
BN4P2N024	€ 7,90	24 mm	35 mm	36 mm	50 mm
BN4P2N025	€ 7,90	25 mm	36 mm	35 mm	52 mm
BN4P2N026	€ 7,90	26 mm	37 mm	36 mm	52 mm
BN4P2N027	€ 9,60	27 mm	38 mm	36 mm	52 mm
BN4P2N028	€ 9,60	28 mm	39 mm	38 mm	52 mm
BN4P2N029	€ 9,60	29 mm	40 mm	38 mm	52 mm
BN4P2N030	€ 9,60	30 mm	42 mm	38 mm	54 mm
BN4P2N032	€ 9,60	32 mm	43 mm	38 mm	56 mm
BN4P2N033	€ 10,10	33 mm	44 mm	38 mm	56 mm
BN4P2N034	€ 10,70	34 mm	46 mm	38 mm	56 mm
BN4P2N035	€ 10,70	35 mm	47 mm	42 mm	56 mm
BN4P2N036	€ 10,70	36 mm	48 mm	42 mm	58 mm
BN4P2N038	€ 12,50	38 mm	50 mm	42 mm	58 mm
BN4P2N041	€ 14,10	41 mm	52 mm	45 mm	60 mm
BN4P2N046	€ 15,60	46 mm	56 mm	45 mm	64 mm
BN4P2N050	€ 18,80	50 mm	62 mm	48 mm	68 mm
BN4P2N055	€ 24,20	55 mm	68 mm	48 mm	72 mm
BN4P2N060	€ 30,00	60 mm	74 mm	48 mm	76 mm

**PN402NX**
**ALARGADERA**

Colgante

Cr-V

Cromado

3/4"

3/4"

Art.	€	Longitud
PN402N200A	€ 19,80	200 mm
PN402N400A	€ 30,50	400 mm

**LN400N3/4A**
**€ 32,70**
**MANGO CORREDIZO**

Colgante

Cr-V

Cromado

3/4"

Longitud	500 mm
----------	--------

**RN4023NA**
**€ 9,00**
**REDUCTOR**

Con cuadradillo hembra 3/4" y macho 1/2"

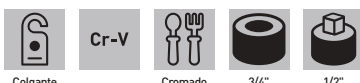

Colgante

Cr-V

Cromado

3/4"

1/2"

Longitud	50 mm
----------	-------

**JN402NA**
**€ 45,20**
**ARTICULACION UNIVERSAL**

Colgante

Cr-V

Cromado

3/4"

3/4"

Longitud	110 mm
----------	--------



0795/2

€ 67,20

**JUEGO DE LLAVES MULTILOCK**

Adecuados a tuercas y tornillos XZN, metricos, pulgadas y torx.



19 Pcs



Estuche de transporte



Cr-V



Cromado



1/2"

Medidas	8 - 9 - 10 - 11 - 12 - 13 - 14 - 15 - 16 - 17 - 18 - 19 - 20 - 21 - 22 - 24 - 27 - 30 - 32 mm
Medidas en pulgadas	3/8" - 7/16" - 15/32" - 1/2" - 19/32" - 5/8" - 3/4" - 25/32" - 13/16" - 7/8" - 15/16" - 1-1/16" - 1-13/16" - 1-1/4"
Medidas en torx	E12 - E14 - E16 - E18 - E20 - E22 - E24 - E26 - E28 - E30 - E34 - E38 - E40
Medidas en XZN	M12 - M14 - M16 - M18

0795/1

€ 24,40

**JUEGO DE LLAVES MULTILOCK**

Adecuados a tuercas y tornillos XZN, metricos, pulgadas y torx.



13 Pcs



Estuche de transporte



Cr-V



Cromado



1/4"

Medidas	4 - 4,5 - 5 - 5,5 - 6 - 7 - 8 - 9 - 10 - 11 - 12 - 13 - 14 mm
Medidas en pulgadas	5/32" - 7/32" - 1/4" - 5/16" - 11/32" - 3/8" - 7/16" - 15/32" - 1/2"
Medidas en torx	E5 - E6 - E8 - E10 - E12 - E14 - E16 - E18
Medidas en XZN	M5 - M6 - M8 - M9 - M10 - M12 - M14 - M16 - M18

0195

€ 48,90

**JUEGO DE LLAVES DE VASO PERFIL TORX**

Adecuados para tornillos torx.



28 Pcs



Estuche de transporte



Cr-V



Cromado



1/4" | 3/8" | 1/2"

Medidas en torx	1/4": E4 - E5 - E6 - E7 - E8 - E10 - E11 3/8": E4 - E5 - E6 - E7 - E8 - E10 - E11 - E12 - E14 - E16 - E18 - E20 1/2": E10 - E11 - E12 - E14 - E16 - E18 - E20 - E22 - E24
-----------------	---



**0589**
**€ 75,10**
**JUEGO DE LLAVES DE VASOS MULTI PERFIL REBAJADO**

Compuesto de 11 vasos multi perfil con agujero pasante en acero CR-V, 1 llave de carraca reversible perfil bajo agujero pasante y accesorios. adecuado para métrico, pulgadas, torx, XZN, barra roscada y prisioneros. permite trabajar en espacios reducidos.



24 Pcs



Estuche de transporte



Cr-V



Cromado



72 dientes



1/4"

Casquillos	4.5 - 5 - 5.5 - 6 - 7 - 8 - 9 - 10 - 11 - 12 - 13 mm
Carraca reversible	1 Pcs
Prolongación	50 mm
Adaptador	1/4"
Adaptador insertos	1 Pcs
Insertos	PH: 1 - 2 - 3 (S2) Torx: T10-T15-T20-T25-T30-T40 (S2)

**0624**
**€ 70,70**
**JUEGO DE LLAVES DE VASO DE 1/4"**

46 Pcs



Estuche de transporte



Cr-V



Cromado

Llaves de vaso de 1/4"	4 - 4.5 - 5 - 5.5 - 6 - 7 - 8 - 9 - 10 - 11 - 12 - 13 - 14 mm
Llaves de vaso con insertos	1/4" : T8 - T10 - T15 - T20 - T25 - T30 - T40 - H3 - H4 - H5 - H6 - H7 - H8 - SL4 - SL5.5 - SL7 - PH1 - PH2 - PH3 - PZ1 - PZ2 - PZ3
Carraca reversible	1/4"
Alargadera flexible	1/4" - 150 mm
Prolongaciones de 1/4"	50 - 100 mm
Mango per llaves de vaso	1/4"
Articulacion universal	1/4"
Mango corredizo	1/4"
Llaves hexagonales	1,27 - 1,5 - 2 - 2,5 mm

**S520**
**€ 43,10**
**JUEGO DE LLAVES DE VASO DE 6 CARAS DE 1/4"**

20 Pcs



Estuche de transporte



Cr-V



Cromado



1/4"

Llaves de vaso de 1/4"	5/32", 3/16", 7/32", 1/4", 9/32", 5/16", 11/32", 3/8", 13/32", 7/16", 15/32", 1/2", 9/16"
Articulacion universal	1/4"
Prolongaciones de 1/4"	2", 4", 6"
Mango corredizo	1/4"
Mango per llaves de vaso	1/4"
Carraca reversible	1/4"

**0679**
**€ 80,90**
**JUEGO DE LLAVES DE VASO DE 3/8" Y 1/4"**

42 Pcs



Estuche de transporte



Cr-V



Satinado



1/4" | 3/8"

Llaves de vaso de 3/8"	9 - 10 - 11 - 12 - 13 - 14 - 15 - 17 - 19 mm
Medida de llaves de vaso para bujias	3/8" : 16 - 21 mm
Prolongaciones de 3/8"	75 - 150 mm
Articulacion universal	3/8"
Amplificador	F. 1/2" - M. 3/8"
Carraca reversible	3/8"
Llaves de vaso de 1/4"	4 - 4.5 - 5 - 5.5 - 6 - 7 - 8 - 9 - 10 - 11 - 12 - 13 mm
Mango per llaves de vaso	1/4"
Amplificador	F. 3/8" - M. 1/4"
Llave de vaso porta insertos	1/4"
Insertos	PH1 - PH2 - PH3 - H3 - H4 - H5 - H6 - H7 - SL4 - SL5.5 - SL7



**S328**

€ 141,00

**JUEGO DE LLAVES DE VASO DE 1/2"**



28 Pcs	Estuche de transporte	Cr-V	Cromado	1/2"
Llaves de vaso de 1/2"		8 - 9 - 10 - 11 - 12 - 13 - 14 - 15 - 16 - 17 - 18 - 19 - 20 - 21 - 22 - 23 - 24 - 27 - 30 - 32 mm		
Medida de llaves de vaso para bujias		1/2" : 16 - 21 mm		
Prolongaciones de 1/2"		75 - 150 - 250 mm		
Articulacion universal		1/2"		
Amplificador		F. 3/8" - M. 1/2"		
Carraca reversible		1/2"		

**SN4P3N027**

€ 125,00

**JUEGO DE LLAVES DE VASO DE 6 CARAS DE 1/2"**

Con 20 llaves de vaso normal, 2 llaves de vaso para bujias, 1 carraca reversible, 1 articulacion universal, 2 alargaderas y 1 mango corredizo.



27 Pcs	Estuche de transporte	Cr-V	Cromado	1/2"
Medida de llaves de vaso normal		5/16", 3/8", 7/16", 15/32", 1/2", 9/16", 19/32", 5/8", 11/16", 3/4", 25/32", 13/16", 7/8", 15/16", 1", 1-1/16", 1-3/16", 1-1/4", 23/32", 1-1/8"		
Medida de llaves de vaso para bujias		5/8", 13/16"		
Alargaderas		3", 10"		

**0620**

€ 125,00

**JUEGO DE LLAVES DE VASO DE 1/2"**



24 Pcs	Estuche de transporte	Cr-V	Cromado	1/2"
Llaves de vaso de 1/2"		10 - 11 - 12 - 13 - 14 - 15 - 16 - 17 - 18 - 19 - 20 - 21 - 22 - 23 - 24 - 27 - 30 - 32 mm		
Medida de llaves de vaso para bujias		1/2" : 21 mm		
Prolongaciones de 1/2"		125 - 250 mm		
Articulacion universal		1/2"		
Mango corredizo		1/2"		
Carraca reversible		1/2"		

**0181**

€ 167,00

**JUEGO DE LLAVES DE VASO DE 3/4"**



20 Pcs	Estuche de transporte	40 Cr	Satinado	3/4"
Medidas		19 - 21 - 22 - 23 - 24 - 26 - 27 - 30 - 32 - 34 - 36 - 38 - 41 - 46 - 48 - 50 mm		
Carraca reversible		3/4"		
Mango corredizo		3/4"		
Alargaderas		3/4" : 100 - 200 mm		

**0621**
**NEW € 41,90**
**JUEGO DE VASOS DE 3/8" CON INSERTOS HEXAGONALES**

**Conexión** 3/8"  
**LLaves de vaso con insertos exagonal** 2,5 - 3 - 4 - 5 - 6 - 7 - 8 - 10 mm

**0622**
**€ 53,20**
**JUEGO DE LLAVES DE VASO TORX DE 1/2"**

**Medidas** T20 - T25 - T27 - T30 - T40 T45 - T50 - T55 - T60 - T70

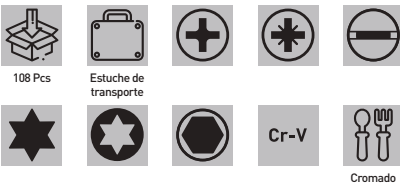
**S108**
**€ 188,00**
**JUEGO DE LLAVES DE VASO**

LLaves de vaso de 1/4"	4 - 4.5 - 5 - 5.5 - 6 - 7 - 8 - 9 - 10 - 11 - 12 - 13 - 14 mm
LLaves de vaso largas de 1/4"	6 - 7 - 8 - 9 - 10 - 11 - 12 - 13 mm
LLaves de vaso largas de 1/4"	Torx: E4 - E5 - E6 - E7 - E8 mm
LLaves de vaso de 1/2"	10 - 11 - 12 - 13 - 14 - 15 - 16 - 17 - 18 - 19 - 20 - 21 - 22 - 24 - 27 - 30 - 32 mm
LLaves de vaso largas de 1/2"	14 - 15 - 17 - 19 - 22 mm
LLaves de vaso de 1/2"	Torx: E10 - E11 - E12 - E14 - E16 - E18 - E20 - E24
LLaves de vaso con insertos	1/4" : T8 - T10 - T15 - T20 - T25 - T27 - T30 - H3 - H4 - H5 - H6 - SL4 - SL5.5 - SL6.5 - PH1 - PH2 - PZ1 - PZ2
Medida de llaves de vaso para bujias	1/2" : 16 - 21 mm
LLave de vaso porta insertos	1/2"
Insertos	5/16" x 30mm : H7 - H8 - H10 - H12 - H14 - SL8 - SL10 - SL12 - PH3 - PH4 - PZ3 - PZ4 - T40 - T45 - T50 - T55 - T60
Prolongaciones de 1/4"	50 - 85 mm
Prolongaciones de 1/2"	125 - 250 mm
Mango per llaves de vaso	1/4"
Ampliador	F. 3/8" - M. 1/2"
Articulacion universal	1/4"
Articulacion universal	1/2"
Mango corredizo	1/4"
Carraca reversible	1/4"
Carraca reversible	1/2"
LLaves hexagonales	1,5 - 2 - 2,5 mm





0618

€ 208,00

**JUEGO DE LLAVES DE VASO DE 1/2" Y 1/4"**



Llaves de vaso de 1/4"	4 - 4.5 - 5 - 5.5 - 6 - 7 - 8 - 9 - 10 - 11 - 12 - 13 - 14 mm
Llaves de vaso largas de 1/4"	6 - 7 - 8 - 9 - 10 - 11 - 12 - 13 mm
Adaptador macho con cuadradillo de 1/4" y hex de 1/4"	1 Pc
Llaves de vaso de 1/2"	10 - 11 - 12 - 13 - 14 - 15 - 16 - 17 - 18 - 19 - 20 - 21 - 22 - 23 - 24 - 27 - 30 - 32 mm
Llaves de vaso largas de 1/2"	14 - 15 - 17 - 19 mm
Alargadera flexible	1/4" - 150 mm
Llaves de vaso con insertos	1/4": T8 - T10 - T15 - T20 - T25 - T30 - H3 - H4 - H5 - H6 - SL4 - SL5.5 - SL7 - PH1 - PH2 - PZ1 - PZ2
Medida de llaves de vaso para bujias	1/2": 16 - 21 mm
Llave de vaso por insertos de 5/16"	1/2"
Insertos	5/16" x 30mm : H8 - H10 - H12 - H14 - SL8 - SL10 - SL12 - PH3 - PH4 - PZ3 - PZ4 - T40 - T45 - T50 - T55
Prolongaciones de 1/4"	50 - 100 mm
Prolongaciones de 1/2"	125 - 250 mm
Mango per llaves de vaso	1/4"
Amplificador	F. 3/8" - M. 1/2"
Articulacion universal	1/4"
Articulacion universal	1/2"
Mango corredizo	1/4"
Carraca reversible	1/4"
Carraca reversible	1/2"
Llaves hexagonales	1,5 - 2 - 2,5 mm



S179

€ 322,00

**JUEGO DE LLAVES DE VASO**

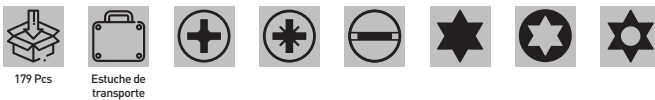

Llaves de vaso de 1/4"	4 - 4.5 - 5 - 5.5 - 6 - 7 - 8 - 9 - 10 - 11 - 12 - 13 - 14 mm
Llaves de vaso largas de 1/4"	6 - 7 - 8 - 9 - 10 mm
Llaves de vaso largas de 1/4"	Torx: E4 - E5 - E6 - E7 - E8 mm
Prolongaciones de 1/4"	50 - 100 mm
Mango corredizo	1/4"
Llave de vaso porta insertos	1/4"
Llaves de vaso con insertos	1/4" - Torx: T8 - T9 - T10 - T15 - T20 - T25 - T27 - T30
Llaves de vaso con insertos con agujero de guia	1/4" - Torx: T8H - T9H - T10H - T15H - T20H - T25H - T27H - T30H
Llaves de vaso con insertos	1/4": PH0 - PH1 - PH2
Llaves de vaso con insertos	1/4": PZ0 - PZ1 - PZ2
Llaves de vaso con insertos exagonal	1/4": 3 - 4 - 5 - 6 mm
Llaves de vaso con insertos a punta recta	1/4": 4 - 5.5 - 6.5 - 7 mm
Articulacion universal	1/4"
Mango per llaves de vaso	1/4"
Carraca reversible	1/4"
Llaves de vaso de 3/8"	10 - 11 - 12 - 13 - 14 - 15 - 16 - 17 - 18 - 19 mm
Llaves de vaso de 3/8"	Torx: E10 - E11 - E12 - E13
Llaves de vaso largas de 3/8"	10 - 11 - 12 - 13 - 14 - 15 mm
Medida de llaves de vaso para bujias	3/8" - 18 mm
Prolongaciones de 3/8"	150 mm
Llave de vaso por insertos de 5/16"	3/8"
Articulacion universal	3/8"
Carraca reversible	3/8"
Llaves de vaso de 1/2"	10 - 11 - 12 - 13 - 14 - 15 - 16 - 17 - 18 - 19 - 20 - 21 - 22 - 24 - 27 - 30 - 32 mm
Llaves de vaso largas de 1/2"	16 - 17 - 18 - 19 - 22 mm
Llaves de vaso de 1/2"	Torx: E16 - E18 - E20 - E24
Medida de llaves de vaso para bujias	1/2": 16 - 21 mm
Prolongaciones de 1/2"	125 - 250 mm
Llave de vaso por insertos de 5/16"	1/2"
Articulacion universal	1/2"
Amplificador	F. 3/8" - M. 1/2"
Carraca reversible	1/2"
Insertos	1/4" x 25 mm XZN: M5 - M6 - M8



Insertos	1/4" x 25 mm Torx: T5 - T6 - T7 - T8 - T9 - T10 - T15 - T20 - T25 - T27 - T30
Insertos	1/4" x 25 mm Ribe: RM5 - RM6 - RM7 - RM8 - RM9
Insertos	1/4" x 25 mm Torx "5": TS7 - TS10 - TS15 - TS20 - TS25 - TS27 - TS30 - TS40 - TS45
Insertos	5/16" x 30 mm Torx: T40 - T45 - T50 - T55 - T60 - T70
Puntas con agujero de guia	5/16" x 30 mm Torx: T40H - T45H - T50H - T55H - T60H - T70H
Puntas hexagonal	5/16" x 30 mm: 7 - 8 - 10 - 12 - 14 mm
Insertos	5/16" x 30 mm: PH3 - PH4
Insertos	5/16" x 30 mm: PZ3 - PZ4
Puntas boca recta	5/16" x 30 mm: 8 - 10 - 12 mm
Llaves hexagonales	1,3 - 1,5 - 2 - 2,5 - 3 - 4 - 5 mm

**BI4E3NX**
**LLAVE DE VASO DE IMPACTO, SERIE NORMAL**

**Cr-Mo**



Fosfatado



3124

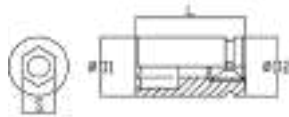

1/2"



Art.	€	Medida	D1	D2	Longitud
BI4E3N008	€ 4,24	8 mm	15 mm	24 mm	38 mm
BI4E3N009	€ 4,24	9 mm	16 mm	24 mm	38 mm
BI4E3N010	€ 4,24	10 mm	17,5 mm	24 mm	38 mm
BI4E3N011	€ 4,24	11 mm	18,5 mm	24 mm	38 mm
BI4E3N012	€ 4,24	12 mm	19,5 mm	24 mm	38 mm
BI4E3N013	€ 4,24	13 mm	20,5 mm	24 mm	38 mm
BI4E3N014	€ 4,24	14 mm	22 mm	24 mm	38 mm
BI4E3N015	€ 4,79	15 mm	24 mm	24 mm	38 mm
BI4E3N016	€ 4,79	16 mm	24 mm	24 mm	38 mm
BI4E3N017	€ 4,79	17 mm	26 mm	26 mm	38 mm
BI4E3N018	€ 4,79	18 mm	28 mm	28 mm	38 mm
BI4E3N019	€ 4,79	19 mm	28 mm	28 mm	38 mm
BI4E3N020	€ 5,80	20 mm	30 mm	30 mm	38 mm
BI4E3N021	€ 5,80	21 mm	30 mm	30 mm	38 mm
BI4E3N022	€ 5,80	22 mm	32 mm	30 mm	38 mm
BI4E3N023	€ 6,10	23 mm	34 mm	30 mm	38 mm
BI4E3N024	€ 6,10	24 mm	34 mm	30 mm	38 mm
BI4E3N025	€ 6,10	25 mm	36 mm	30 mm	38 mm
BI4E3N026	€ 6,80	26 mm	36 mm	30 mm	38 mm
BI4E3N027	€ 6,80	27 mm	38 mm	30 mm	42 mm
BI4E3N028	€ 8,10	28 mm	40 mm	30 mm	42 mm
BI4E3N029	€ 8,10	29 mm	42 mm	30 mm	42 mm
BI4E3N030	€ 8,70	30 mm	42 mm	30 mm	42 mm
BI4E3N031	€ 8,90	31 mm	44 mm	30 mm	42 mm
BI4E3N032	€ 9,80	32 mm	44 mm	30 mm	44 mm

**BI4E3LX**
**LLAVE DE VASO DE IMPACTO LARGA**

**Cr-Mo**

Fosfatado



3124



1/2"



Art.	€	Medida	D1	D2	Longitud
BI4E3L008	€ 7,00	8 mm	15 mm	24 mm	78 mm
BI4E3L009	€ 7,00	9 mm	16 mm	24 mm	78 mm
BI4E3L010	€ 7,00	10 mm	17,5 mm	24 mm	78 mm
BI4E3L011	€ 7,00	11 mm	18,5 mm	24 mm	78 mm
BI4E3L012	€ 7,00	12 mm	19,5 mm	24 mm	78 mm
BI4E3L013	€ 7,00	13 mm	20,5 mm	24 mm	78 mm
BI4E3L014	€ 7,00	14 mm	22 mm	24 mm	78 mm
BI4E3L015	€ 8,40	15 mm	24 mm	24 mm	78 mm
BI4E3L016	€ 8,40	16 mm	24 mm	24 mm	78 mm
BI4E3L017	€ 8,40	17 mm	26 mm	26 mm	78 mm
BI4E3L018	€ 8,40	18 mm	28 mm	28 mm	78 mm
BI4E3L019	€ 8,40	19 mm	28 mm	28 mm	78 mm
BI4E3L020	€ 8,40	20 mm	30 mm	30 mm	78 mm
BI4E3L021	€ 8,40	21 mm	30 mm	30 mm	78 mm
BI4E3L022	€ 8,70	22 mm	32 mm	30 mm	78 mm
BI4E3L023	€ 8,90	23 mm	34 mm	30 mm	78 mm
BI4E3L024	€ 10,20	24 mm	34 mm	30 mm	78 mm
BI4E3L025	€ 11,10	25 mm	36 mm	30 mm	78 mm
BI4E3L026	€ 11,30	26 mm	36 mm	30 mm	78 mm
BI4E3L027	€ 11,30	27 mm	38 mm	30 mm	78 mm
BI4E3L028	€ 12,00	28 mm	40 mm	30 mm	78 mm
BI4E3L029	€ 12,00	29 mm	42 mm	30 mm	78 mm
BI4E3L030	€ 12,00	30 mm	42 mm	30 mm	78 mm
BI4E3L031	€ 12,40	31 mm	44 mm	30 mm	78 mm
BI4E3L032	€ 12,40	32 mm	44 mm	30 mm	78 mm





**BI413LOX**

LLAVE DE VASO DE IMPACTO CON PUNTA HEX MACHO



Cr-Mo



Fosfatado

3129

1/2"



Art.	€	Medida	D	Longitud
BI413L004	€ 6,60	4 mm	25 mm	78 mm
BI413L005	€ 6,60	5 mm	25 mm	78 mm
BI413L006	€ 6,60	6 mm	25 mm	78 mm
BI413L008	€ 6,60	8 mm	25 mm	78 mm
BI413L010	€ 6,60	10 mm	25 mm	78 mm
BI413L012	€ 6,60	12 mm	25 mm	78 mm
BI413L014	€ 6,60	14 mm	25 mm	78 mm
BI413L017	€ 7,50	17 mm	25 mm	78 mm
BI413L019	€ 8,10	19 mm	25 mm	78 mm

**BI423LX**

LLAVE DE VASO DE IMPACTO CON PUNTA TORX MACHO



Cr-Mo



Fosfatado

3129

1/2"



Art.	€	Medida	D	Longitud
BI423L025	€ 7,50	T25	25 mm	78 mm
BI423L027	€ 7,50	T27	25 mm	78 mm
BI423L030	€ 7,50	T30	25 mm	78 mm
BI423L040	€ 8,00	T40	25 mm	78 mm
BI423L045	€ 8,10	T45	25 mm	78 mm
BI423L050	€ 8,10	T50	25 mm	78 mm
BI423L060	€ 10,50	T60	25 mm	78 mm
BI423L070	€ 11,80	T70	25 mm	78 mm
BI423L080	€ 12,20	T80	25 mm	78 mm

**BI433MX**

LLAVE DE VASO DE IMPACTO CON PUNTA RIBE MACHO



Cr-Mo



Fosfatado

3121-3129

1/2"



Art.	€	Medida	D	Longitud
BI433M004	€ 6,50	M 4	25 mm	60 mm
BI433M005	€ 6,50	M 5	25 mm	60 mm
BI433M006	€ 6,50	M 6	25 mm	60 mm
BI433M007	€ 6,50	M 7	25 mm	60 mm
BI433M008	€ 6,50	M 8	25 mm	60 mm
BI433M009	€ 6,50	M 9	25 mm	60 mm
BI433M010	€ 6,50	M 10	25 mm	60 mm
BI433M012	€ 7,50	M 12	25 mm	60 mm
BI433M014	€ 8,10	M 14	25 mm	60 mm
BI433M016	€ 8,40	M 16	25 mm	60 mm
BI433M018	€ 8,70	M 18	25 mm	60 mm

**BI443MX**

LLAVE DE VASO DE IMPACTO CON PUNTA XZN MACHO



Cr-Mo



Fosfatado

3121-3129

1/2"



Art.	€	Medida	D	Longitud
BI443M004	€ 6,50	M 4	25 mm	60 mm
BI443M005	€ 6,50	M 5	25 mm	60 mm
BI443M006	€ 6,50	M 6	25 mm	60 mm
BI443M008	€ 6,50	M 8	25 mm	60 mm
BI443M010	€ 6,50	M 10	25 mm	60 mm
BI443M012	€ 6,50	M 12	25 mm	60 mm
BI443M014	€ 6,80	M 14	25 mm	60 mm
BI443M016	€ 7,00	M 16	25 mm	60 mm
BI443M018	€ 7,60	M 18	25 mm	60 mm
BI443M020	€ 8,10	M 20	25 mm	60 mm

**PI403X**

ALARGADERA DE IMPACTO



Cr-Mo



Fosfatado



3121-3129

1/2"



Art.	€	D	Longitud
PI403075	€ 8,40	25 mm	75 mm
PI403125	€ 9,10	25 mm	125 mm
PI403150	€ 11,10	25 mm	150 mm
PI403250	€ 13,80	25 mm	250 mm

**PI453X**

ALARGADERA A LIBERACION RAPIDA DE IMPACTO



Cr-Mo



Fosfatado



3121-3129

1/2"



Art.	€	D	Longitud
PI453075	€ 19,80	25 mm	75 mm
PI453150	€ 21,40	25 mm	125 mm
PI453250	€ 24,20	25 mm	250 mm

**BI4E2NX**
**LLAVE DE VASO DE IMPACTO, SERIE NORMAL**

**Cr-Mo**



Fosfatado



3121-3129

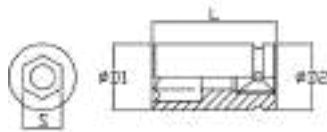

3/4"



Art.	€	Medida	D1	D2	Longitud
BI4E2N018	€ 11,10	18 mm	30 mm	44 mm	51 mm
BI4E2N019	€ 11,10	19 mm	32 mm	44 mm	51 mm
BI4E2N020	€ 11,10	20 mm	33 mm	44 mm	51 mm
BI4E2N021	€ 11,10	21 mm	35 mm	44 mm	51 mm
BI4E2N022	€ 11,10	22 mm	36 mm	44 mm	51 mm
BI4E2N023	€ 11,10	23 mm	38 mm	44 mm	51 mm
BI4E2N024	€ 11,10	24 mm	39 mm	44 mm	51 mm
BI4E2N025	€ 11,10	25 mm	41 mm	44 mm	54 mm
BI4E2N026	€ 11,10	26 mm	41 mm	44 mm	54 mm
BI4E2N027	€ 11,10	27 mm	42 mm	44 mm	54 mm
BI4E2N028	€ 11,90	28 mm	44 mm	44 mm	54 mm
BI4E2N029	€ 11,90	29 mm	46 mm	44 mm	54 mm
BI4E2N030	€ 11,90	30 mm	46 mm	44 mm	54 mm
BI4E2N032	€ 13,20	32 mm	48 mm	44 mm	57 mm
BI4E2N033	€ 13,20	33 mm	50 mm	44 mm	57 mm
BI4E2N034	€ 14,30	34 mm	52 mm	44 mm	57 mm
BI4E2N035	€ 14,40	35 mm	52 mm	44 mm	57 mm
BI4E2N036	€ 14,60	36 mm	54 mm	44 mm	57 mm
BI4E2N038	€ 17,00	38 mm	56 mm	44 mm	57 mm
BI4E2N041	€ 18,90	41 mm	60 mm	44 mm	58 mm
BI4E2N046	€ 20,80	46 mm	66 mm	44 mm	68 mm
BI4E2N050	€ 32,30	50 mm	71 mm	54 mm	68 mm
BI4E2N055	€ 39,60	55 mm	77 mm	54 mm	73 mm
BI4E2N060	€ 42,90	60 mm	84 mm	54 mm	75 mm
BI4E2N065	€ 48,10	65 mm	88 mm	54 mm	78 mm

**BI4E2LX**
**LLAVE DE VASO DE IMPACTO LARGA**

**Cr-Mo**



Fosfatado



3121-3129

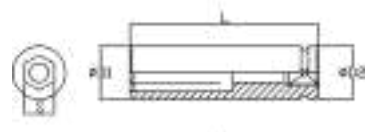

3/4"



Art.	€	Medida	D1	D2	Longitud
BI4E2L018	€ 19,80	18 mm	30 mm	44 mm	90 mm
BI4E2L019	€ 19,80	19 mm	32 mm	44 mm	90 mm
BI4E2L020	€ 19,80	20 mm	33 mm	44 mm	90 mm
BI4E2L021	€ 19,80	21 mm	35 mm	44 mm	90 mm
BI4E2L022	€ 19,80	22 mm	36 mm	44 mm	90 mm
BI4E2L023	€ 19,80	23 mm	38 mm	44 mm	90 mm
BI4E2L024	€ 19,80	24 mm	39 mm	44 mm	90 mm
BI4E2L025	€ 19,80	25 mm	41 mm	44 mm	90 mm
BI4E2L026	€ 19,80	26 mm	41 mm	44 mm	90 mm
BI4E2L027	€ 19,80	27 mm	42 mm	44 mm	90 mm
BI4E2L028	€ 19,80	28 mm	44 mm	44 mm	90 mm
BI4E2L029	€ 19,80	29 mm	46 mm	44 mm	90 mm
BI4E2L030	€ 19,80	30 mm	46 mm	44 mm	90 mm
BI4E2L032	€ 21,30	32 mm	48 mm	44 mm	90 mm
BI4E2L033	€ 21,30	33 mm	50 mm	44 mm	90 mm
BI4E2L034	€ 21,80	34 mm	52 mm	44 mm	90 mm
BI4E2L035	€ 21,80	35 mm	52 mm	44 mm	90 mm
BI4E2L036	€ 21,80	36 mm	54 mm	44 mm	90 mm
BI4E2L038	€ 25,80	38 mm	56 mm	44 mm	90 mm
BI4E2L041	€ 27,30	41 mm	60 mm	44 mm	90 mm
BI4E2L046	€ 35,50	46 mm	66 mm	44 mm	90 mm
BI4E2L050	€ 44,10	50 mm	71 mm	54 mm	90 mm

**PI402X**
**ALARGADERA DE IMPACTO**

**Cr-Mo**

Fosfatado



3121-3129



3/4"



Art.	€	D	Longitud
PI402175	€ 31,60	44 mm	175 mm
PI402200	€ 34,90	44 mm	200 mm
PI402300	€ 45,70	44 mm	300 mm
PI402400	€ 64,60	44 mm	400 mm





**BI4E1NX**

**LLAVE DE VASO DE IMPACTO**



Cr-Mo



Fosfatado



3129



1"

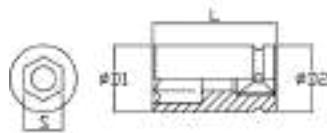

Art.	€	Medida	D1	D2	Longitud
BI4E1N021	€ 20,50	21 mm	38 mm	54 mm	58 mm
BI4E1N022	€ 20,50	22 mm	39 mm	54 mm	58 mm
BI4E1N023	€ 20,50	23 mm	41 mm	54 mm	58 mm
BI4E1N024	€ 20,50	24 mm	42 mm	54 mm	58 mm
BI4E1N025	€ 20,50	25 mm	43 mm	54 mm	58 mm
BI4E1N026	€ 20,50	26 mm	44 mm	54 mm	58 mm
BI4E1N027	€ 20,50	27 mm	46 mm	54 mm	58 mm
BI4E1N028	€ 20,50	28 mm	47 mm	54 mm	58 mm
BI4E1N029	€ 20,50	29 mm	48 mm	54 mm	58 mm
BI4E1N030	€ 20,50	30 mm	49 mm	54 mm	62 mm
BI4E1N031	€ 20,50	31 mm	50 mm	54 mm	62 mm
BI4E1N032	€ 20,50	32 mm	52 mm	54 mm	62 mm
BI4E1N033	€ 20,50	33 mm	54 mm	54 mm	62 mm
BI4E1N034	€ 22,70	34 mm	54 mm	54 mm	62 mm
BI4E1N035	€ 22,70	35 mm	54 mm	54 mm	62 mm
BI4E1N036	€ 23,50	36 mm	56 mm	54 mm	65 mm
BI4E1N037	€ 24,00	37 mm	57 mm	54 mm	65 mm
BI4E1N038	€ 27,00	38 mm	58 mm	54 mm	65 mm
BI4E1N039	€ 27,00	39 mm	59 mm	54 mm	65 mm
BI4E1N040	€ 27,00	40 mm	60 mm	54 mm	65 mm
BI4E1N041	€ 27,00	41 mm	61 mm	54 mm	68 mm
BI4E1N042	€ 30,20	42 mm	64 mm	54 mm	68 mm
BI4E1N043	€ 30,20	43 mm	66 mm	54 mm	68 mm
BI4E1N044	€ 30,20	44 mm	66 mm	54 mm	68 mm
BI4E1N045	€ 30,20	45 mm	67 mm	54 mm	68 mm
BI4E1N046	€ 30,20	46 mm	68 mm	54 mm	72 mm
BI4E1N047	€ 33,80	47 mm	69 mm	54 mm	72 mm
BI4E1N048	€ 33,80	48 mm	70 mm	54 mm	72 mm
BI4E1N050	€ 33,80	50 mm	74 mm	54 mm	75 mm
BI4E1N052	€ 42,00	52 mm	75 mm	54 mm	75 mm
BI4E1N054	€ 42,00	54 mm	78 mm	54 mm	80 mm
BI4E1N055	€ 43,60	55 mm	80 mm	54 mm	83 mm
BI4E1N056	€ 46,80	56 mm	81 mm	54 mm	83 mm
BI4E1N060	€ 46,80	60 mm	86 mm	54 mm	87 mm
BI4E1N065	€ 51,00	65 mm	92 mm	54 mm	90 mm
BI4E1N070	€ 57,40	70 mm	97 mm	54 mm	93 mm
BI4E1N075	€ 67,90	75 mm	104 mm	86 mm	95 mm
BI4E1N080	€ 95,70	80 mm	112 mm	86 mm	95 mm
BI4E1N085	€ 110,00	85 mm	115 mm	86 mm	100 mm
BI4E1N090	€ 123,00	90 mm	124 mm	86 mm	105 mm
BI4E1N095	€ 154,00	95 mm	130 mm	86 mm	105 mm
BI4E1N100	€ 191,00	100 mm	135 mm	86 mm	105 mm

**BI4E1LX**

**LLAVE DE VASO DE IMPACTO LARGA**



Cr-Mo



Fosfatado



3129



1"

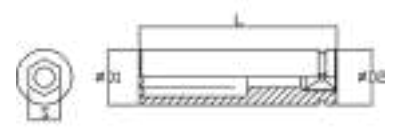

Art.	€	Medida	D1	D2	Longitud
BI4E1L021	€ 28,50	21 mm	38 mm	54 mm	90 mm
BI4E1L022	€ 28,50	22 mm	39 mm	54 mm	90 mm
BI4E1L023	€ 28,50	23 mm	41 mm	54 mm	90 mm
BI4E1L024	€ 28,50	24 mm	42 mm	54 mm	90 mm
BI4E1L027	€ 28,50	27 mm	46 mm	54 mm	90 mm
BI4E1L028	€ 28,50	28 mm	47 mm	54 mm	90 mm
BI4E1L030	€ 28,50	30 mm	49 mm	54 mm	90 mm
BI4E1L032	€ 28,50	32 mm	52 mm	54 mm	90 mm
BI4E1L033	€ 28,50	33 mm	54 mm	54 mm	90 mm
BI4E1L034	€ 28,80	34 mm	54 mm	54 mm	90 mm
BI4E1L035	€ 29,00	35 mm	54 mm	54 mm	90 mm
BI4E1L036	€ 29,00	36 mm	56 mm	54 mm	90 mm
BI4E1L038	€ 33,40	38 mm	58 mm	54 mm	95 mm
BI4E1L039	€ 35,00	39 mm	59 mm	54 mm	95 mm
BI4E1L040	€ 35,00	40 mm	60 mm	54 mm	95 mm
BI4E1L041	€ 35,90	41 mm	61 mm	54 mm	95 mm
BI4E1L042	€ 35,90	42 mm	64 mm	54 mm	95 mm
BI4E1L043	€ 38,00	43 mm	66 mm	54 mm	95 mm
BI4E1L044	€ 38,00	44 mm	66 mm	54 mm	95 mm
BI4E1L045	€ 38,70	45 mm	67 mm	54 mm	95 mm
BI4E1L046	€ 38,70	46 mm	68 mm	54 mm	95 mm
BI4E1L048	€ 47,40	48 mm	70 mm	54 mm	100 mm
BI4E1L049	€ 48,90	49 mm	72 mm	54 mm	100 mm
BI4E1L050	€ 48,90	50 mm	74 mm	54 mm	100 mm
BI4E1L051	€ 50,50	51 mm	74 mm	54 mm	100 mm
BI4E1L052	€ 51,30	52 mm	74 mm	54 mm	100 mm
BI4E1L054	€ 51,30	54 mm	78 mm	54 mm	100 mm
BI4E1L055	€ 55,20	55 mm	80 mm	54 mm	105 mm
BI4E1L057	€ 57,50	57 mm	82 mm	54 mm	105 mm
BI4E1L060	€ 76,20	60 mm	86 mm	54 mm	110 mm
BI4E1L065	€ 91,60	65 mm	92 mm	54 mm	115 mm
BI4E1L070	€ 91,20	70 mm	97 mm	54 mm	120 mm
BI4E1L075	€ 133,00	75 mm	104 mm	86 mm	135 mm
BI4E1L080	€ 144,00	80 mm	112 mm	86 mm	135 mm
BI4E1L085	€ 151,00	85 mm	115 mm	86 mm	140 mm
BI4E1L090	€ 198,00	90 mm	124 mm	86 mm	140 mm
BI4E1L095	€ 258,00	95 mm	130 mm	86 mm	140 mm

**I340 € 247,00**

**JUEGO DE LLAVES DE VASOS DE IMPACTO, SERIE NORMAL Y LARGAS**



40 Pcs Estuche de transporte

Cr-Mo Fosfatado 1/2"

LLaves de vaso de 1/2"	9 - 10 - 11 - 12 - 13 - 14 - 15 - 16 - 17 - 18 - 19 - 20 - 21 - 22 - 23 - 24 - 26 - 27 - 30 mm
LLaves de vaso largas de 1/2"	9 - 10 - 11 - 12 - 13 - 14 - 15 - 16 - 17 - 18 - 19 - 20 - 21 - 22 - 23 - 24 - 26 - 27 - 30 mm
Articulacion universal	1/2"
Prolongaciones de 1/2"	125 mm

**SI4E3N013 € 62,30**

**JUEGO DE VASOS DE IMPACTO HEXAGONALES**

Caja de metal.

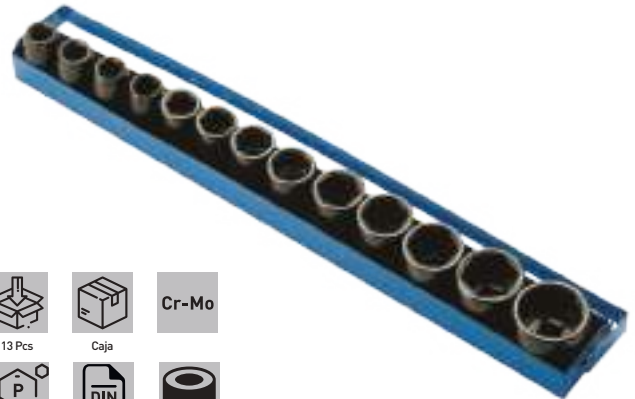

13 Pcs Caja Cr-Mo

Fosfatado 3129 1/2"

Casquillos	10, 11, 12, 13, 14, 16, 17, 19, 21, 22, 24, 27, 30 mm
------------	---

**SI413M006 € 54,40**

**SET LLAVES DE VASO DE IMPACTO DE 6 CARAS MACHO**



6 Pcs Estuche de transporte

Cr-Mo Fosfatado 3129

Casquillos	8, 10, 12, 14, 17, 19 mm
Longitud	60 mm

**SI423M006 € 62,30**

**SET LLAVES DE VASO DE IMPACTO TORX MACHO**



6 Pcs Estuche de transporte

Cr-Mo Fosfatado 3129

Casquillos	T40, T45, T50, T55, T60, T70
Longitud	60 mm

**0341-X**

**LLAVES DE VASO HEXAGONALES REVISTIDAS DE PLASTICO**



Cr-Mo 1/2"

Art.	€	Medida	Longitud
0341/17	€ 9,20	17 mm	87 mm
0341/19	€ 9,20	19 mm	87 mm
0341/21	€ 9,20	21 mm	87 mm
0341/22	€ 11,40	22 mm	87 mm
0341/24	€ 13,00	24 mm	87 mm

**0341 € 38,70**

**JUEGO DE LLAVES DE VASO HEXAGONALES REVISTIDAS DE PLASTICO**



3 Pcs Caja Cr-Mo 1/2"

Medidas	17 - 19 - 21 mm
Longitud	87 mm



**0341/5S**

€ 54,40

**JUEGO DE LLAVES DE VASO HEXAGONALES REVESTIDAS DE PLASTICO**

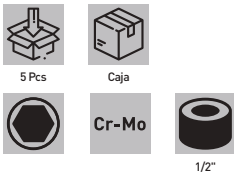

Medidas	17 - 19 - 21 - 22 - 24 mm
Longitud	87 mm

**0341-XL**

**LLAVES DE VASO LARGAS HEXAGONALES REVESTIDAS DE PLASTICO**

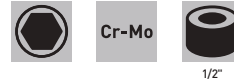

Art.	€	Medida	Longitud
0341/17L	€ 18,10	17 mm	150 mm
0341/19L	€ 18,10	19 mm	150 mm
0341/21L	€ 18,10	21 mm	150 mm

**0341/3LS**

€ 59,70

**JUEGO DE LLAVES DE VASO HEXAGONALES REVESTIDAS DE PLASTICO**

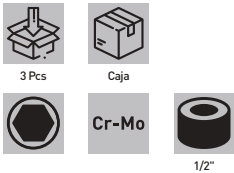

Medidas	17 - 19 - 21 mm
Longitud	150 mm

**0341-SX**

**FUNDA DE PLÁSTICO PARA LLAVES DE VASO HEXAGONALES**



Plastic

Art.	€	Medida
0341/S19	€ 1,08	19 mm
0341/S21	€ 1,08	21 mm
0341/S22	€ 1,08	22 mm
0341/S24	€ 1,08	24 mm

**I306**

€ 74,00

**JUEGO DE LLAVES DE VASO DE IMPACTO LARGAS**



Medidas	17 - 19 - 21 mm
Longitud	150 mm

**I217**

€ 326,00

**SET LLAVES DE VASO DE IMPACTO, SERIE NORMAL**

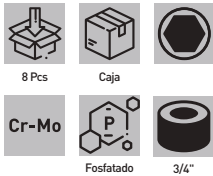

Medidas	19 - 21 - 22 - 24 - 27 - 30 - 32 - 33 - 34 - 35 - 36 - 38 - 40 - 41 - 46 - 50 - 55 mm
---------	---

**SI4E2N008**
**€ 116,00**
**JUEGO DE VASOS DE IMPACTO HEXAGONALES**

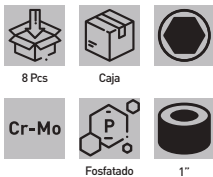
**Casquillos** 26, 27, 29, 30, 32, 35, 36, 38 mm

**SI4E1N008**
**€ 170,00**
**JUEGO DE VASOS DE IMPACTO HEXAGONALES**

**Casquillos** 24, 27, 30, 32, 33, 36, 38, 41 mm

**PI401X**
**ALARGADERA DE IMPACTO**

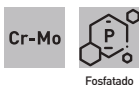

Art.	€	D	Longitud
PI401175	€ 43,50	54 mm	175 mm
PI401200	€ 46,70	54 mm	200 mm
PI401250	€ 56,50	54 mm	250 mm
PI401300	€ 60,20	54 mm	300 mm
PI401400	€ 76,20	54 mm	400 mm

**JI40XN**
**ARTICULACION UNIVERSAL DE IMPACTO**

Con cuadradillo macho y hembra de 1", fabricado en aleación de acero 42CRM02.

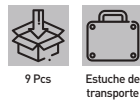

Art.	€	Conexión cuadrado	D	Longitud
JI401N	€ 88,90	1"	54 mm	115 mm
JI402N	€ 55,70	3/4"	44 mm	90 mm
JI403N	€ 23,50	1/2"	30 mm	63 mm

**I109**
**€ 186,00**
**SET LLAVES DE VASO DE IMPACTO**

**Llaves de vaso de 1"** 21 - 22 - 24 - 26 - 30 - 38 mm  
**Llaves largas de 1"** 27 - 28 - 32 mm

**SI40N006**
**€ 39,20**
**JUEGO DE REDUCTORES Y AMPLIADORES DE IMPACTO**

**Medidas** 1/4" int. - 3/8" ext.; 3/8" int. - 1/4" ext.; 3/8" int. - 1/2" ext.; 1/2" int. - 3/8" ext.; 1/2" int. - 3/4" ext.  
**Maletín de plástico** 126 x 100 x 52 mm

**JI40XL**
**ARTICULACION UNIVERSAL DE IMPACTO**

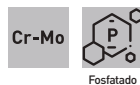
Serie fuerte, con cuadradillo macho y hembra de 1", fabricado en aleación de acero 42CRM02.



Art.	€	Conexión cuadrado	Longitud	D
JI401L	€ 88,90	1"	130 mm	54 mm
JI402L	€ 55,70	3/4"	105 mm	44 mm

**RI40X**
**REDUCTOR DE IMPACTO**

Art.	€	Conexión hembra	Conexión macho	D	Longitud
RI4012N	€ 20,70	1"	3/4"	54 mm	70 mm
RI4021N	€ 16,50	3/4"	1"	44 mm	63 mm
RI4023N	€ 12,80	3/4"	1/2"	44 mm	58 mm
RI4032N	€ 9,10	1/2"	3/4"	30 mm	48 mm



**0471**

€ 6,20

**GANCHOS PARA QUITAR OR**

También adecuado para la eliminación de juntas del motor.



Longitud 135 mm

**0456**

€ 6,20

**GANCHOS PARA QUITAR OR**

Con mango hexagonal con imán.

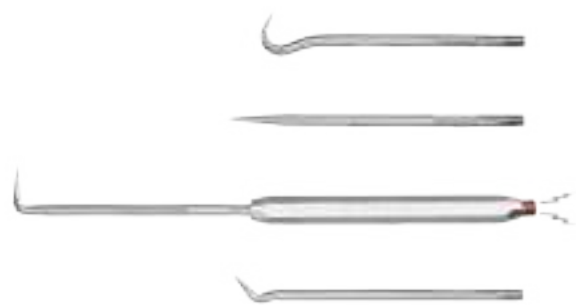

Dimensiones del mango 8 x 90 mm

**E003**

€ 22,60

**JUEGO DE 5 EXTRACTORES DE HSS**



Nº 0	2-3 mm
Nº 1	4-5 mm
Nº 2	6-8 mm
Nº 3	8-10 mm
Nº 4	10-12 mm



**E001**

€ 14,80

**JUEGO EXTRACTORES PARA TORNILLOS**



Nº 1	M3 - M6
Nº 2	M6 - M8
Nº 3	M8 - M11
Nº 4	M11 - M14
Nº 5	M14 - M18



**E005**

€ 37,00

**JUEGO DE EXTRACTORES**

Para tuercas y tornillos con exterior hexagonal.



Medidas 9 - 10 - 11 - 12 - 13 - 14 - 15 - 16 - 17 - 19 mm  
 Altura 27 mm



**E191-**
**EXTRACTOR DE 3 BRAZOS**

Art.	€	Dimensiones
E191/120	€ 60,50	Max Ø 120 mm - h 101 mm
E191/200	€ 113,00	Max Ø 200 mm - h 150 mm

**E190-**
**EXTRACTOR DE 2 BRAZOS**

Art.	€	Dimensiones
E190/080	€ 31,50	Max Ø 80 mm - h 100 mm
E190/130	€ 41,20	Max Ø 130 mm - h 100 mm
E190/160	€ 50,60	Max Ø 160 mm - h 150 mm
E190/200	€ 54,60	Max Ø 200 mm - h 150 mm

**E190-BX**
**BRAZOS PROLONGADOS**

Art.	€	Longitud
E190/B2	€ 30,20	300 mm



**CB01-**

**LLAVE DE VASO CON MANGO DE PLASTICO**

Ansi, con agujero profundo.



Art.	€	Medida	L	L1	L2	L3	L4	A	B	C
CB01/04	€ 6,10	4 mm	185 mm	75 mm	4 ~ 5 mm	20,5 mm	110 mm	Ø 5,9 mm	Ø 7 mm	Ø 3,3 mm
CB01/05	€ 6,10	5 mm	185 mm	75 mm	4,5 ~ 5,5 mm	20 mm	110 mm	Ø 5,9 mm	Ø 8,3 mm	Ø 3,7 mm
CB01/055	€ 6,10	5,5 mm	185 mm	75 mm	5,5 ~ 6,5 mm	19 mm	110 mm	Ø 5,9 mm	Ø 9 mm	Ø 3,7 mm
CB01/06	€ 6,10	6 mm	185 mm	75 mm	6,5 ~ 7,5 mm	18 mm	110 mm	Ø 5,9 mm	Ø 9,5 mm	Ø 3,7 mm
CB01/07	€ 6,50	7 mm	185 mm	75 mm	7,5 ~ 8,5 mm	17 mm	110 mm	Ø 5,9 mm	Ø 10,5 mm	Ø 3,7 mm
CB01/08	€ 6,50	8 mm	185 mm	75 mm	8,5 ~ 9,5 mm	16 mm	110 mm	Ø 7,2 mm	Ø 11,9 mm	Ø 5 mm
CB01/09	€ 6,50	9 mm	185 mm	75 mm	8,5 ~ 9,5 mm	16 mm	110 mm	Ø 7,2 mm	Ø 12,8 mm	Ø 5 mm
CB01/10	€ 7,00	10 mm	185 mm	75 mm	10,5 ~ 11,5 mm	14 mm	110 mm	Ø 9,3 mm	Ø 14,1 mm	Ø 7 mm
CB01/11	€ 7,00	11 mm	185 mm	75 mm	10,5 ~ 11,5 mm	14 mm	110 mm	Ø 9,3 mm	Ø 15 mm	Ø 7 mm
CB01/12	€ 7,00	12 mm	185 mm	75 mm	10,5 ~ 11,5 mm	14 mm	110 mm	Ø 9,3 mm	Ø 16 mm	Ø 7 mm
CB01/13	€ 7,00	13 mm	185 mm	75 mm	11,5 ~ 12,5 mm	14 mm	110 mm	Ø 11 mm	Ø 17 mm	Ø 8,5 mm

**CB02-**

**LLAVE DE VASO CON MANGO DE PLASTICO**

Ansi, con agujero profundo.



Art.	€	Medida	L	L1	L2	L3	L4	A	B	C
CB02/04	€ 7,70	4 mm	185 mm	75 mm	4 ~ 5 mm	75 mm	110 mm	Ø 7,2 mm	Ø 7 mm	Ø 3,3 mm
CB02/05	€ 7,70	5 mm	185 mm	75 mm	4,5 ~ 5,5 mm	13,3 mm	110 mm	Ø 7,2 mm	Ø 8,3 mm	Ø 3,7 mm
CB02/055	€ 7,70	5,5 mm	185 mm	75 mm	5,5 ~ 6,5 mm	74,5 mm	110 mm	Ø 7,2 mm	Ø 9 mm	Ø 3,7 mm
CB02/06	€ 7,70	6 mm	185 mm	75 mm	6,5 ~ 7,5 mm	65 mm	110 mm	Ø 7,2 mm	Ø 9,5 mm	Ø 3,7 mm
CB02/07	€ 8,10	7 mm	185 mm	75 mm	7,5 ~ 8,5 mm	64,5 mm	110 mm	Ø 7,2 mm	Ø 10,5 mm	Ø 3,7 mm
CB02/08	€ 8,10	8 mm	185 mm	75 mm	8,5 ~ 9,5 mm	101 mm	110 mm	Ø 9,3 mm	Ø 11,9 mm	Ø 5 mm
CB02/09	€ 8,10	9 mm	185 mm	75 mm	8,5 ~ 9,5 mm	101 mm	110 mm	Ø 9,3 mm	Ø 12,8 mm	Ø 5 mm
CB02/10	€ 8,10	10 mm	185 mm	75 mm	10,5 ~ 11,5 mm	94,5 mm	110 mm	Ø 9,3 mm	Ø 14,1 mm	Ø 7 mm
CB02/11	€ 9,10	11 mm	185 mm	75 mm	10,5 ~ 11,5 mm	64 mm	110 mm	Ø 11 mm	Ø 15 mm	Ø 7 mm
CB02/12	€ 9,10	12 mm	185 mm	75 mm	10,5 ~ 11,5 mm	130 mm	110 mm	Ø 11 mm	Ø 16 mm	Ø 7 mm
CB02/13	€ 10,10	13 mm	185 mm	75 mm	11,5 ~ 12,5 mm	70 mm	110 mm	Ø 11 mm	Ø 17 mm	Ø 8,5 mm

**CBF1-**

**LLAVE DE VASO FLEXIBLE CON MANGO DE PLASTICO**

Ansi.



Art.	€	Medida	L	L1	L2	L3	A	B
CBF1/05	€ 7,70	5 mm	265 mm	150 mm	9,5 mm	115 mm	Ø 11 mm	Ø 11,8 mm
CBF1/055	€ 7,70	5,5 mm	265 mm	150 mm	9,5 mm	115 mm	Ø 11 mm	Ø 11,8 mm
CBF1/06	€ 7,70	6 mm	265 mm	150 mm	9,5 mm	115 mm	Ø 11 mm	Ø 11,8 mm
CBF1/07	€ 7,70	7 mm	265 mm	150 mm	9,5 mm	115 mm	Ø 11 mm	Ø 11,8 mm
CBF1/08	€ 7,70	8 mm	265 mm	150 mm	9,5 mm	115 mm	Ø 11 mm	Ø 11,8 mm
CBF1/09	€ 7,80	9 mm	265 mm	150 mm	9,5 mm	115 mm	Ø 11 mm	Ø 13 mm
CBF1/10	€ 8,10	10 mm	265 mm	150 mm	10 mm	115 mm	Ø 11 mm	Ø 14,5 mm
CBF1/11	€ 8,60	11 mm	265 mm	150 mm	9 mm	115 mm	Ø 11 mm	Ø 15,9 mm
CBF1/12	€ 8,60	12 mm	265 mm	150 mm	9 mm	115 mm	Ø 11 mm	Ø 17 mm
CBF1/13	€ 8,60	13 mm	265 mm	150 mm	8,5 mm	115 mm	Ø 11 mm	Ø 17,8 mm

**CBF1/10P**
**€ 74,80**
**JUEGO DE LLAVES DE VASO FLEXIBLE CON MANGO DE PLASTICO**

Ansi, bicomponente.



Medidas 5 - 5,5 - 6 - 7 - 8 - 9 - 10 - 11 - 12 - 13 mm

**CB01/04P**
**€ 27,70**
**JUEGO DE LLAVES DE VASO CON MANGO DE PLASTICO**

Ansi, bicomponente.



Medidas 10 - 11 - 12 - 13 mm

**CB01/07P**
**€ 42,40**
**JUEGO DE LLAVES DE VASO CON MANGO DE PLASTICO**

Ansi, bicomponente.



Medidas 4 - 5 - 5,5 - 6 - 7 - 8 - 9 mm

**CB01/11P**
**€ 68,70**
**JUEGO DE LLAVES DE VASO CON MANGO DE PLASTICO**

Ansi, bicomponente.



Medidas 4 - 5 - 5,5 - 6 - 7 - 8 - 9 - 10 - 11 - 12 - 13 mm

**CB02/04P**
**€ 35,40**
**JUEGO DE LLAVES VASO CON MANGO DE PLASTICO**

Ansi, bicomponente con agujero profundo.



Medidas 10 - 11 - 12 - 13 mm

**CB02/07P**
**€ 55,40**
**JUEGO DE LLAVES DE VASO CON MANGO DE PLASTICO**

Ansi, bicomponente con agujero profundo.



Medidas 4 - 5 - 5,5 - 6 - 7 - 8 - 9 mm

**CB02/11P**
**€ 89,90**
**JUEGO DE LLAVES DE VASO CON MANGO DE PLASTICO**

Ansi, bicomponente con agujero profundo.



Medidas 4 - 5 - 5,5 - 6 - 7 - 8 - 9 - 10 - 11 - 12 - 13 mm

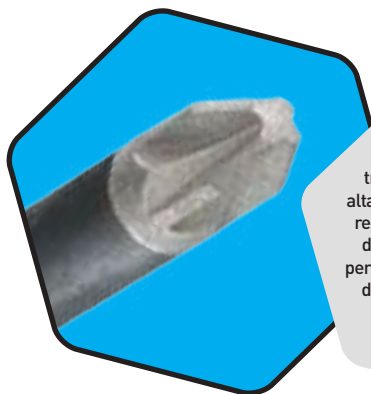

**DIN 2380-1**

Con hoja negra y mango tricomponente de resina TPR altamente elástica y polipropileno resistente al aceite. La punta de diamante garantiza un agarre perfecto, evitando dañar la cabeza del tornillo. Este tipo de punta también es muy eficaz con tornillos ya dañados.

**D883-**

**DESTORNILLADOR ELECTRICISTA BOCA RECTA DE DIAMANTE**

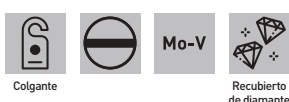

Art.	€	Medida	Longitud barra	Longitud total
D883/3075	€ 3,13	3 mm	75 mm	115 mm
D883/4100	€ 4,24	4 mm	100 mm	145 mm

**D884/6038**

€ 3,94

**DESTORNILLADOR BOCA RECTA DE DIAMANTE**

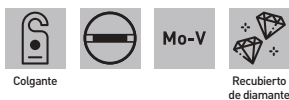

Medida	6 mm
Longitud barra	38 mm
Longitud total	70 mm

**D882/2038**

€ 4,03

**DESTORNILLADOR PUNTA PH CON BOCA DE DIAMANTE**



Medida	PH 2
Longitud barra	38 mm
Longitud total	70 mm

**D885/2038**

€ 3,94

**DESTORNILLADOR PUNTA POZIDRIV CON BOCA DE DIAMANTE**



Medida	PZ 2
Longitud barra	38 mm
Longitud total	70 mm

**D884-**

**DESTORNILLADOR BOCA RECTA DE DIAMANTE**



Art.	€	Medida	Longitud barra	Longitud total
D884/3075	€ 3,33	3 mm	75 mm	115 mm
D884/4100	€ 4,03	4 mm	100 mm	180 mm
D884/5125	€ 4,55	5 mm	125 mm	230 mm
D884/6150	€ 5,30	6 mm	150 mm	260 mm
D884/8150	€ 6,40	8 mm	150 mm	210 mm

**D882-**

**DESTORNILLADOR PUNTA PHILLIPS CON BOCA DE DIAMANTE**



Art.	€	Medida	Longitud barra	Longitud total
D882/1075	€ 4,55	PH 1	75 mm	180 mm
D882/2100	€ 5,90	PH 2	100 mm	210 mm
D882/3150	€ 6,60	PH 3	150 mm	270 mm

**D885-**

**DESTORNILLADOR PUNTA POZIDRIV CON BOCA DE DIAMANTE**



Art.	€	Medida	Longitud barra	Longitud total
D885/1075	€ 4,55	PZ 1	75 mm	120 mm
D885/2100	€ 5,80	PZ 2	100 mm	150 mm
D885/3150	€ 6,60	PZ 3	150 mm	210 mm

**D880/006**

€ 25,10

**JUEGO DE DESTORNILLADORES CON TIP DE DIAMANTE**

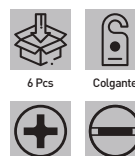

Medidas corte	(-) 4 x 100 mm, (-) 5 x 125 mm, (-) 6 x 150 mm
Cruz	(+) PH 1 x 75 mm, (+) PH 2 x 100 mm, (+) PH 3 x 150 mm

**C884-**
**DESTORNILLADOR BOCA RECTA MECANICO.**

Punta magnética fosfatada en negro y mango en resina TPR elastica y polipropileno resistente a los aceites.

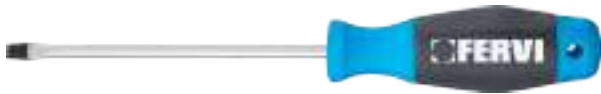

Art.	€	Medida	Longitud barra	Longitud total
C884/3075	€ 1,82	3 mm	75 mm	155 mm
C884/4100	€ 2,80	4 mm	100 mm	200 mm
C884/5125	€ 3,33	5 mm	125 mm	225 mm
C884/6150	€ 3,74	6 mm	150 mm	260 mm
C884/8150	€ 4,36	8 mm	150 mm	260 mm

**C884/6038**
**€ 2,91**
**DESTORNILLADOR BOCA RECTA MECANICO.**

Punta magnética fosfatada en negro y mango en resina TPR elastica y polipropileno resistente a los aceites.



Medida	6 mm
Longitud barra	38 mm
Longitud total	100 mm

**C882-**
**DESTORNILLADOR PUNTA PH.**

Punta magnética fosfatada en negro y mango en resina TPR elástica y polipropileno resistente a los aceites.



Art.	€	Medida	Longitud barra	Longitud total
C882/1075	€ 3,33	PH 1	75 mm	180 mm
C882/2100	€ 4,36	PH 2	100 mm	210 mm
C882/3150	€ 4,64	PH 3	150 mm	260 mm

**C882/2038**
**€ 2,91**
**DESTORNILLADOR PUNTA PH.**

Con punta magnética fosfatada en negro y mango en resina TPR elástica y polipropileno resistente a los aceites.



Medida	PH 2
Longitud barra	38 mm
Longitud total	100 mm

**C885-**
**DESTORNILLADOR PUNTA POZIDRIV.**

Punta magnética fosfatada en negro y mango en resina TPR elastica y polipropileno resistente a los aceites.



Art.	€	Medida	Longitud barra	Longitud total
C885/1075	€ 3,33	PZ 1	75 mm	170 mm
C885/2100	€ 4,36	PZ 2	100 mm	210 mm
C885/3150	€ 4,64	PZ 3	150 mm	260 mm

**C885/2038**
**€ 2,91**
**DESTORNILLADOR PUNTA POZIDRIV.**

Punta magnética fosfatada en negro y mango en resina TPR elastica y polipropileno resistente a los aceites.



Medida	PZ 2
Longitud barra	38 mm
Longitud total	100 mm



**C883-**

**DESTORNILLADOR BOCA RECTA ELECTRICISTA.**

Destornillador recto punta electricista, punta magnética fosfatada en negro y mango en resina TPR elastica y polipropileno resistente a los aceites.

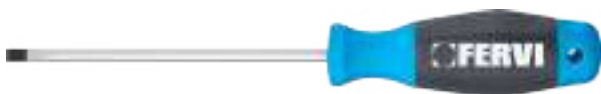

Art.	€	Medida	Longitud barra	Longitud total
C883/3075	€ 1,82	3 mm	75 mm	160 mm
C883/4100	€ 2,68	4 mm	100 mm	200 mm

**C881-**

**DESTORNILLADOR TORX**

Punta magnética fosfatada en negro y mango en resina TPR elastica y polipropileno resistente a los aceites.



Art.	€	Medidas	Longitud barra	Longitud total
C881/07075	€ 1,21	T7	75 mm	160 mm
C881/08075	€ 1,21	T8	75 mm	160 mm
C881/10075	€ 1,21	T10	75 mm	160 mm
C881/15100	€ 1,76	T15	100 mm	200 mm
C881/20100	€ 1,76	T20	100 mm	200 mm
C881/25125	€ 1,93	T25	125 mm	225 mm
C881/27125	€ 1,93	T27	125 mm	225 mm
C881/30150	€ 2,51	T30	150 mm	260 mm
C881/35150	€ 3,01	T35	150 mm	260 mm
C881/40150	€ 3,01	T40	150 mm	260 mm

**C880/006**

€ 25,10

**JUEGO DE DESTORNILLADORES RECTOS + PH**

Punta magnética fosfatada en negro y mango en resina TPR elastica y polipropileno resistente a los aceites.

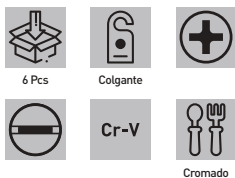

Corte	(-) 4 x 100 mm, (-) 5 x 125 mm, (-) 6 x 150 mm
Cruz	(+) PH 1 x 75 mm, (+) PH 2 x 100 mm, (+) PH 3 x 150 mm

**C881/006**

€ 11,00

**JUEGO DE DESTORNILLADORES TORX**

Punta magnética fosfatada en negro y mango en resina TPR elastica y polipropileno resistente a los aceites.

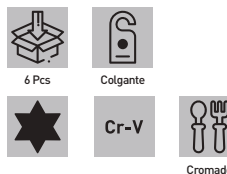

Torx	T10x75mm, T15x100mm, T20x100mm, T25x125mm, T27x125mm, T30x150mm
------	---

**0633**

€ 15,90

**JUEGO DE DESTORNILLADORES CON CABEZA DE ACERO**



Corte	(-) 5,0x1,0x75 mm, (-) 6,0x1,2x100 mm, (-) 6,0x1,2x125 mm, (-) 8,0x1,2x150 mm
Cruz	(+) PH 1x5x75 mm, (+) PH 2x6x100 mm

**0634**

€ 12,50

**JUEGO DE DESTORNILLADORES**

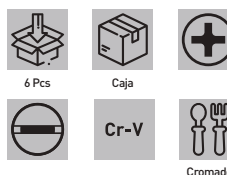

Corte	(-) 4x0,8x75 mm, (-) 5,5x1,0x100 mm, (-) 6,5x1,2x150 mm
Cruz	(+) PH 0x3x75 mm, (+) PH 1x5x100 mm, (+) PH 2x6x125 mm

**CI82-**
**DESTORNILLADOR EN CRUZ AISLADO**

1000V IEC 60900, punta magnética fosfatada en negro y mango bi-color en polipropileno resistente a los aceites.



Colgante

Art.	€	Medida	Longitud barra	Longitud total
CI82/0060	€ 3,02	PH0 x 3 mm	60 mm	160 mm
CI82/1080	€ 3,94	PH1 x 4,5 mm	80 mm	185 mm
CI82/2100	€ 4,64	PH2 x 6 mm	100 mm	210 mm
CI82/3150	€ 7,70	PH3 x 8 mm	150 mm	265 mm

**CI83-**
**DESTORNILLADOR BOCA RECTA ELECTRICISTA AISLADO**

1000V IEC 60900, punta magnética fosfatada en negro y mango bi-color en polipropileno resistente a los aceites.



Colgante

Art.	€	Medida	Longitud barra	Longitud total
CI83/25075	€ 3,02	0,4 x 2,5 mm	75 mm	175 mm
CI83/30100	€ 3,94	0,6 x 3 mm	100 mm	200 mm
CI83/40100	€ 3,94	0,8 x 4 mm	100 mm	200 mm
CI83/55125	€ 4,24	1 x 5,5 mm	125 mm	230 mm
CI83/65150	€ 5,60	1,2 x 6,5 mm	150 mm	260 mm
CI83/80175	€ 7,40	1,6 x 8 mm	175 mm	290 mm

**CI80/006**
**€ 22,80**
**JUEGO DE DESTORNILLADORES AISLADOS**

1000V IEC 60900, punta magnética fosfatada en negro y mango bi-color en polipropileno resistente a los aceites.



6 Pcs

Colgante

Corte	(-) 0,6 x 3 x 100 mm, (-) 0,8 x 4 x 100 mm, (-) 1 x 5,5 x 125 mm
Cruz	(+) PH 0 x 3 x 60 mm, (+) PH 1 x 4,5 x 80 mm, (+) PH 2 x 6 x 100 mm

**0083**
**€ 11,90**
**DESTORNILLADOR DE GOLPE**

Con estuche de plástico.



7 Pcs

Caja

Acero

Satinado

Dimensiones	165 x 42 mm
Insertos	6
Conexión	5/16"

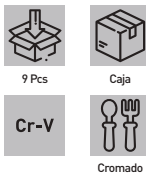
**0207**
**€ 15,10**
**JUEGO DE DESTORNILLADORES DE CABEZA DOBLE**

9 Pcs

Caja

Cr-V

Cromado

Longitud hoja	110 mm
Longitud del mango	170 mm





**P883-**

**DESTORNILLADOR DE PRECISI3N BOCA RECTA**

Con punta magn3tica bruñida, mango en material de dos componentes con extremo libre para girar para un agarre perfecto.

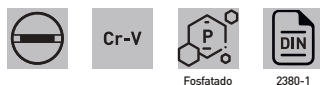

Art.	€	Medida	Longitud barra	Longitud total
P883/1250	€ 2,82	1,2 mm	50 mm	140 mm
P883/1650	€ 2,82	1,6 mm	50 mm	140 mm
P883/1850	€ 2,82	1,8 mm	50 mm	140 mm
P883/2050	€ 2,82	2,0 mm	50 mm	140 mm
P883/2450	€ 2,82	2,4 mm	50 mm	140 mm
P883/3050	€ 2,82	3,0 mm	50 mm	140 mm
P883/3550	€ 2,82	3,5 mm	50 mm	140 mm
P883/4050	€ 2,82	4,0 mm	50 mm	140 mm

**P882-**

**DESTORNILLADOR DE PRECISI3N PH**

Con punta magn3tica bruñida, mango en material de dos componentes con extremo libre para girar para un agarre perfecto.

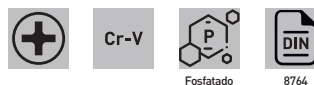

Art.	€	Medida	Longitud barra	Longitud total
P882/0150	€ 2,82	PH 1	50 mm	140 mm
P882/1050	€ 2,82	PH 0	50 mm	140 mm
P882/2050	€ 2,82	PH 00	50 mm	140 mm

**P881-**

**DESTORNILLADOR DE PRECISI3N TORX**

Con punta magn3tica bruñida, mango en material de dos componentes con extremo libre para girar para un agarre perfecto.



Art.	€	Medida	Longitud barra	Longitud total
P881/0550	€ 2,82	T5	50 mm	140 mm
P881/0650	€ 2,82	T6	50 mm	140 mm
P881/0750	€ 2,82	T7	50 mm	140 mm
P881/0850	€ 2,82	T8	50 mm	140 mm
P881/0950	€ 2,82	T9	50 mm	140 mm
P881/1050	€ 2,82	T10	50 mm	140 mm
P881/1550	€ 2,82	T15	50 mm	140 mm

**P886-**

**DESTORNILLADOR DE PRECISI3N HEXAGONAL**

Con punta magn3tica bruñida, mango en material de dos componentes con extremo libre para girar para un agarre perfecto.

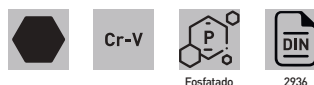

Art.	€	Medida	Longitud barra	Longitud total
P886/1350	€ 2,82	1,3 mm	50 mm	140 mm
P886/1550	€ 2,82	1,5 mm	50 mm	140 mm
P886/2050	€ 2,82	2,0 mm	50 mm	140 mm
P886/2550	€ 2,82	2,5 mm	50 mm	140 mm
P886/3050	€ 2,82	3,0 mm	50 mm	140 mm

**P880/06S**

€ 15,60

**SERIE DE DESTORNILLADORES DE PRECISI3N**

Con punta magn3tica bruñida, mango en material de dos componentes con extremo libre para girar para un agarre perfecto.

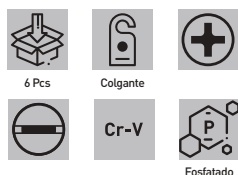

Corte 1,2 x 50 mm, 2 x 50 mm, 3 x 50 mm  
Cruz PH 00 x 50 mm, PH 0 x 50 mm, PH 1 x 50 mm

**P881/06S**

€ 15,60

**SERIE DE DESTORNILLADORES DE PRECISI3N TORX**

Con punta magn3tica bruñida, mango en material de dos componentes con extremo libre para girar para un agarre perfecto.

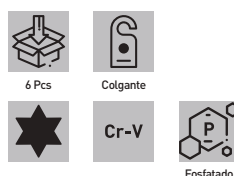

Torx T5 x 50 mm, T6 x 50 mm, T7 x 50 mm, T8 x 50 mm, T9 x 50 mm, T10

**0466/DM € 2,03**
**MAGNETIZADOR/ DESMAGNETIZADOR POR DESTORNILLADORES**

Blister

**Dimensiones** 52 x 50 x 28,5 mm

**0888 € 22,70**
**CABEZAL ANGULAR A 90°, PARA PUNTAS DESTORNILLADOR**

Destornillador.



5 Pcs



Colgante



Aluminio



Satinado

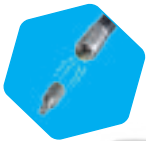

1/4"

**PIF1 € 8,60**
**PORTADESTORNILLADOR FLEXIBLE**

Colgante

Cr-V



1/4"

L	265 mm	L3	115 mm
L1	150 mm	A	10 mm
L2	9,5 mm	B	11,8 mm

**0304 € 7,20**
**PORTADESTORNILLADOR PARA PUNTAS DE 1/4**

Colgante



Cromado



1/4"

**0562N € 4,87**
**PORTADESTORNILLADOR PARA PUNTAS 1/4"**

Mango tricomponente hecho de resina TPR altamente elástica y material de polipropileno resistente al aceite.



Colgante

Cr-V



Cromado

1/4"

**Longitud** 110 mm

**0562 € 6,00**
**PORTADESTORNILLADOR PARA PUNTAS 1/4"**

Mango tricomponente hecho de resina TPR altamente elástica y material de polipropileno resistente al aceite.



Colgante

Cr-V



Cromado

1/4"

**Longitud** 200 mm

**0406 € 3,64**
**PORTA PUNTAS DE 6 CARAS DE CAMBIO RAPIDO**

Expositor

Cr-V



Cromado

1/4"

**Longitud** 60 mm

**0407 € 4,03**
**PORTA PUNTAS**

Derecho y angular 90°, útil para facilitar el trabajo en espacios reducidos.

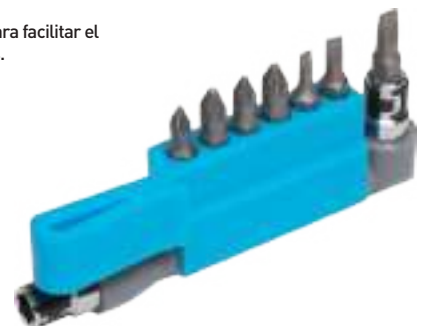

8 Pcs



Colgante



Longitud



Phillips



105 mm

1 - 2

Pozidriv

Corte

1 - 2

2 - 3 - 4 mm



0732

€ 11,00

**JUEGO DE PUNTAS HEXAGONALES**

Compuesto de 30 bits, 1 adaptador de bits y 1 soporte de bits.



33 Pcs



Blister

Cr-V

Porta insertos magnético	1 x 25 mm
Corte	3 - 4 - 5,5 - 7 mm
Llave	3 - 4 - 5 - 6
Phillips	PH1 - PH2 - PH3 - PH4
Pozidriv	PZ1 - PZ2 - PZ3 - PZ4
Torx	T10 - T15 - T20 - T25 - T30 - T35 - T40
Torx con orificio	T10 - T15 - T20 - T25 - T30 - T35 - T40

0403

€ 17,50

**JUEGO DE LLAVES DE VASO Y PUNTAS HEX**

Llaves de vaso con 6 llaves de vaso, 18 puntas, 1 adaptador para llaves de vaso y 1 destornillador a carraca.



26 Pcs



Blister

Cr-V

Mo-V



Niquelada



1/4"



1/4"

Porta insertos con carraca	1
Porta insertos magnético	1
Adaptador	25 mm
Casquillos	5 - 6 - 7 - 8 - 9 - 10 mm
Corte	3 - 4 - 5 - 6 - 7 mm
Phillips	0 - 1 - 2 - 3
Pozidriv	0 - 1 - 2 - 3
Broca cuadrada	S0 - S1 - S2 - S3

0404

€ 15,40

**JUEGO DE LLAVES DE VASO Y PUNTAS HEX**

Llaves de vaso en acero CR-V y puntas hex en acero S2, revestidas de níquel, con porta puntas de cambio rapido.



35 Pcs



Blister

Cr-V

Mo-V



Niquelada



1/4"



1/4"

Adaptador	1 x 25 mm
Porta insertos magnético	1
Prolongación para casquillos	1
Casquillos	5 - 6 - 7 - 8 - 9 - 10 - 11 - 12 mm
Corte	3 - 4 - 5 - 5,5 - 6 - 7 mm
Phillips	0 - 1 - 2 - 3
Pozidriv	0 - 1 - 2 - 3
Broca cuadrada	S0 - S1 - S2 - S3
Torx	T10 - T15 - T20 - T25 - T30 - T40

0402

€ 18,20

**JUEGO DE PUNTAS HEX**

Fabricadas en acero s2 y revestidas a níquel, con 40 puntas y 1 carraca reversible con 72 dientes.



41 Pcs



Blister

Cr-V

Mo-V



Niquelada



1/4"



1/4"

Conexión	1/4"
Corte	3 - 4 - 5 - 5,5 - 6 - 7 mm
Phillips	2 x 0 - 2 x 1 - 2 x 2 - 2 x 3
Pozidriv	2 x 0 - 2 x 1 - 2 x 2 - 2 x 3
Broca cuadrada	S0 - S1 - S2 - S3
Torx	T10 - T15 - T20 - T25 - T27 - T30 - T40
Hexagonales	2 - 2,5 - 3 - 4 - 5 - 5,5 - 6 mm

**PI063**
**€ 27,10**
**KIT DE HERRAMIENTAS DE REPARACIÓN MULTIFUNCIÓN**

Kit de 62 piezas con mango giratorio magnético para reparar con precisión tus herramientas, smartphones, relojes y electrodomésticos. La bandeja magnética y la función click-clack permiten mantener las brocas organizadas sin perderlas.



63 Pcs



Caja

**Cr-V**

Porta insertos magnético	1
Phillips	PH00000-PH0000-PH000-PH00-PH1-PH2
Corte	1 - 1,3 - 1,5 - 2 - 2,5 - 3 - 4
Hexagonales	0,7 - 0,9 - 1,3 - 1,5 - 2 - 2,5 - 3 - 3,5 - 4
Pozidriv	PZ000 - PZ00 - PZ0 - PZ1
Robertson	0 - 1 - 2
Inserto en "Y"	Y0.6 - Y1.5 - Y2.3 - Y3.0
Inserto en estrella	0,8 - 1,2 - 1,5 - 2
Inserto en triángulo	2 - 2,3 - 3
Inserto en "U"	U2.3 - U2.6
G	G3.8 - G4.5
M	M2,5 - M3 - M4
MID	
ICS	

**0358**
**€ 32,30**
**JUEGO DE PUNTAS ATORNILLADOR INTERCAMBIABLES, LLAVES DE VASOS Y DESTORNILLADOR**

122 Pcs



Caja

**Cr-V**

Satinado

1/4"

Insertos	
Phillips	0 - 1 - 2 (x5 Pz/Pcs) - 3
Pozidriv	0 - 1 - 2 (x5 Pz/Pcs) - 3
Corte	3 - 4 - 4,5 - 5 - 5,5 - 6 - 6,5 - 7 - 8 mm
Llave	4 - 6 - 8 - 10
Torx	8 - 10 - 15 - 20 - 25 - 27 - 30 - 35 - 40 - 45
Tripley	1 - 2 - 3 - 4
Torx con orificio	8 - 10 - 15 - 20 - 25 - 27 - 30 - 35 - 40
Torq-set	6 - 8 - 10
Hexagonales métricos	1,5 - 2 - 2,5 - 3 - 4 - 5 - 5,5 - 6 - 8 mm
Robertson	0 - 1 - 2 - 3
Hexagonales pulgadas	1/16 - 5/64 - 3/32 - 7/64 - 1/8 - 9/64 - 5/32 - 3/16 - 7/32 -
XZN	M5 - M6 - M8
Hexagonales con orificio	2 - 2,5 - 3 - 4 - 5 - 6 - 5/64 - 3/32 - 7/64 - 1/8 - 9/64 - 5/32 -
Embrague	1 - 2 - 3
Adaptador macho con cuadradillo de 1/4" y hex de 1/4"	25 mm
Adaptador macho con cuadradillo de 1/4" y hex de 1/4"	50 mm
Inserto en "Y"	1 Pz
Adaptador insertos	1 Pz
Porta insertos magnético	60 mm
Porta insertos	1 Pz
Puntas para llave de vaso con imán	4 - 5 - 6 - 7 - 8 - 9 - 10 - 11 - 12 - 13 - 5/32 - 3/13 - 7/32 -

**0104**
**€ 37,10**
**JUEGO DE INSERTOS**

Conexión hexagonal 3/8"



40 Pcs



Estuche de transporte

**Cr-V**

Satinado



1/2" - 3/8"

1 Casquillo porta insertos 1/2"	10 mm
1 Casquillo porta insertos 3/8"	10 mm
7 Insertos hexagonales 4-5-6-7-8-10-12 mm	30 mm
7 Insertos hexagonales 4-5-6-7-8-10-12 mm	75 mm
5 Insertos "XZN" 5-6-8-10-12 mm	30 mm
5 Insertos "XZN" 5-6-8-10-12 mm	75 mm
7 Insertos TORX T20-T25-T30-T40-T45-T50-T55	30 mm
7 Insertos TORX T20-T25-T30-T40-T45-T50-T55	75 mm





0640

€ 22,70

**JUEGO DE INSERTOS**

Conexión hexagonal 1/4"



100 Pcs



Caja



Satinado

Mo-V



1/4"

Phillips	0 - 1 - 2 (x5 Pz/Pcs) - 3
Pozidriv	0 - 1 - 2 (x5 Pz/Pcs) - 3
Corte	3 - 4 - 4,5 - 5 - 5,5 - 6 - 6,5 - 7 - 8 mm
Llave	4 - 6 - 8 - 10
Torx	8 - 10 - 15 - 20 - 25 - 27 - 30 - 40 - 45
Tripley	1 - 2 - 3 - 4
Torx con orificio	8 - 10 - 15 - 20 - 25 - 27 - 30 - 35 - 40
Torq-set	6 - 8 - 10
Hexagonales métricos	1,5 - 2 - 2,5 - 3 - 4 - 5 - 5,5 - 6 - 8 mm
Robertson	0 - 1 - 2 - 3
Hexagonales pulgadas	1/16 - 5/64 - 3/32 - 7/64 - 1/8 - 9/64 - 5/32 - 3/16 - 7/32 - 1/4
XZN	M5 - M6 - M8
Hexagonales con orificio	2 - 2,5 - 3 - 4 - 5 - 6 - 5/64 - 3/32 - 7/64 - 1/8 - 9/64 - 5/32
Embrague	1 - 2 - 3

0277

€ 33,30

**JUEGO DE LLAVES DE VASO Y PUNTAS HEX**

Con porta insertos y carraca reversible.



58 Pcs



Caja

Cr-V



1/4"



1/4"

Insertos	25 mm
Phillips (25 mm)	1 - 2 - 3
Pozidriv	1 - 2 - 3
Corte	3,5 - 4,5 - 5,5 - 6,5 mm
Llave	4 - 6 - 8
Torx	10 - 15 - 20 - 25 - 27 - 30 - 40
Destornillador de tres alas	1 - 2 - 3 - 4
Torq-set	6 - 8 - 10
Hexagonales	2 - 3 - 4 - 5 - 6 - 8 mm
Robertson	1 - 2 - 3
XZN	5 - 6 - 8
Embrague	1 - 2 - 3
Casquillos hexagonales	5 - 6 - 7 - 8 - 10 mm
Casquillos hexagonales	3/16 - 1/4 - 9/32 - 5/16 - 3/8
Adaptador	1/4"
Inserto en "Y"	1
Adaptador	1
Porta insertos magnético	1
Porta insertos	1
Carraca reversible	1/4"

**IS25-ESX**

**PUNTAS ATORNILLADOR HEXAGONALES**



Mo-V



Fosfatado



3126



1/4"



Art.	€	Medida	Longitud	Pack
IS25/ES2	€ 0,57	2 mm	25 mm	10
IS25/ES25	€ 0,57	2,5 mm	25 mm	10
IS25/ES3	€ 0,57	3 mm	25 mm	10
IS25/ES4	€ 0,57	4 mm	25 mm	10
IS25/ES5	€ 0,57	5 mm	25 mm	10
IS25/ES6	€ 0,57	6 mm	25 mm	10
IS25/ES8	€ 0,86	8 mm	25 mm	10
IS25/ES10	€ 1,38	10 mm	25 mm	10

**IS25-PHX**

**PUNTAS ATORNILLADOR PH**



Mo-V



Fosfatado



3126



1/4"

Art.	€	Medida	Longitud	Pack
IS25/PH0	€ 0,38	PH 0	25 mm	20
IS25/PH1	€ 0,38	PH 1	25 mm	20
IS25/PH2	€ 0,38	PH 2	25 mm	20
IS25/PH3	€ 0,38	PH 3	25 mm	20

**IS25-PHXAS**

**PUNTAS ATORNILLADOR PH ANTI SLIP**



Mo-V



Fosfatado



3126



1/4"

Art.	€	Medida	Longitud	Pack
IS25/PH1AS	€ 0,61	PH 1	25 mm	10
IS25/PH2AS	€ 0,61	PH 2	25 mm	10
IS25/PH3AS	€ 0,61	PH 3	25 mm	10

**IS25-PZX**

**PUNTAS ATORNILLADOR POZIDRIV**



Mo-V



Fosfatado



3126



1/4"

Art.	€	Medida	Longitud	Pack
IS25/PZ1	€ 0,38	PZ 1	25 mm	20
IS25/PZ2	€ 0,38	PZ 2	25 mm	20
IS25/PZ3	€ 0,38	PZ 3	25 mm	20

**IS25-PZXAS**
**PUNTAS ATORNILLADOR POZIDRIV ANTI SLIP**

Art.	€	Medida	Longitud	Pack
IS25/PZ1AS	€ 0,61	PZ 1	25 mm	10
IS25/PZ2AS	€ 0,61	PZ 2	25 mm	10
IS25/PZ3AS	€ 0,61	PZ 3	25 mm	10

**IS25-TXX**
**PUNTAS ATORNILLADOR TORX**

Art.	€	Medida	Longitud	Pack
IS25/TX10	€ 0,46	T10	25 mm	10
IS25/TX15	€ 0,46	T15	25 mm	10
IS25/TX20	€ 0,46	T20	25 mm	10
IS25/TX25	€ 0,46	T25	25 mm	10
IS25/TX30	€ 0,46	T30	25 mm	10
IS25/TX35	€ 0,46	T35	25 mm	10
IS25/TX40	€ 0,46	T40	25 mm	10
IS25/TX45	€ 1,21	T45	25 mm	10
IS25/TX50	€ 1,21	T50	25 mm	10
IS25/TX55	€ 1,38	T55	25 mm	10

**IS50-PHX**
**PUNTAS ATORNILLADOR PH**

Cuerpo con diámetro reducido.



Art.	€	Medida	Longitud	Pack
IS50/PH1	€ 0,77	PH 1	50 mm	10
IS50/PH2	€ 0,77	PH 2	50 mm	10
IS50/PH3	€ 0,77	PH 3	50 mm	10

**IS50-TGX**
**PUNTAS ATORNILLADOR BOCA RECTA**

Cuerpo con diámetro reducido.



Art.	€	Medida	Longitud	Pack
IS50/TG3	€ 1,21	3 x 0,5 mm	50 mm	5
IS50/TG4	€ 1,21	4 x 0,8 mm	50 mm	5
IS50/TG5.5	€ 1,21	5,5 x 0,8 mm	50 mm	5
IS50/TG6	€ 1,21	6 x 1 mm	50 mm	5
IS50/TG8	€ 1,38	8 x 1,2 mm	50 mm	5

**IS25-TGX**
**PUNTAS ATORNILLADOR BOCA RECTA**

Art.	€	Medida	Longitud	Pack
IS25/TG3	€ 0,46	3 x 0,5 mm	25 mm	10
IS25/TG4	€ 0,46	4 x 0,8 mm	25 mm	10
IS25/TG5.5	€ 0,46	5,5 x 0,8 mm	25 mm	10
IS25/TG6	€ 0,46	6 x 1 mm	25 mm	10
IS25/TG8	€ 0,81	8 x 1,2 mm	25 mm	10

**IS50-ESX**
**PUNTAS ATORNILLADOR HEXAGONALES**

Cuerpo con diámetro reducido.



Art.	€	Medida	Longitud	Pack
IS50/ES2	€ 1,17	2 mm	50 mm	5
IS50/ES25	€ 0,96	2,5 mm	50 mm	5
IS50/ES3	€ 0,96	3 mm	50 mm	5
IS50/ES4	€ 0,96	4 mm	50 mm	5
IS50/ES5	€ 0,96	5 mm	50 mm	5
IS50/ES6	€ 0,96	6 mm	50 mm	5
IS50/ES8	€ 1,21	8 mm	50 mm	5
IS50/ES10	€ 1,21	10 mm	50 mm	5

**IS50-PZX**
**PUNTAS ATORNILLADOR POZIDRIV**

Cuerpo con diámetro reducido.



Art.	€	Medida	Longitud	Pack
IS50/PZ1	€ 0,77	PZ 1	50 mm	10
IS50/PZ2	€ 0,77	PZ 2	50 mm	10
IS50/PZ3	€ 0,77	PZ 3	50 mm	10

**IS50-TXX**
**PUNTAS ATORNILLADOR TORX**

Cuerpo con diámetro reducido.



Art.	€	Medida	Longitud	Pack
IS50/TX10	€ 1,38	T10	50 mm	5
IS50/TX15	€ 1,38	T15	50 mm	5
IS50/TX20	€ 1,38	T20	50 mm	5
IS50/TX25	€ 1,38	T25	50 mm	5
IS50/TX30	€ 1,38	T30	50 mm	5
IS50/TX35	€ 1,38	T35	50 mm	5
IS50/TX40	€ 1,38	T40	50 mm	5



**S018**

€ 90,80

**MALETA CON REMACHADORA TUBULAR Y DE TUERCAS MANUALES**



Remaches	50 x Ø 2,4 mm - 50 x Ø 3,2 mm - 50 x Ø 4 mm - 50 x Ø 4,8 mm
Tuercas remachables	50 x M3 - 50 x M4 - 25 x M5 - 25 x M6 - 20 x M8
Descripción	330 x 170 x 150 mm

**0455**

€ 100,00

**REMACHADORA A DOS MANOS PARA TUERCAS REMACHABLES**

Palancas largas para trabajar sin esfuerzo, con 7 boquillas.

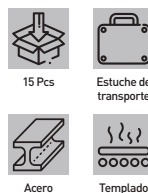

Tuercas remachables	M3 - M4 - M5 - M6 - M8 - M10 - M12
Longitud	400 mm

**0469**

€ 55,40

**REMACHADORA PARA TUERCAS REMACHABLES**

Con 4 varillas roscadas y 4 cabezas.

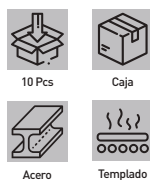

Tuercas remachables	M3 - M4 - M5 - M6
Longitud	200 mm

**0453**

€ 44,80

**REMACHADORA PROFESIONAL A DOS MANOS**

Palancas largas para trabajar sin esfuerzo, incluso con remaches de 6,4 mm. Depósito de plástico para recuperar los clavos cizallados.



Remaches	Ø 3,2 - 4,0 - 4,8 - 6,0 - 6,4 mm
Longitud	400 mm

**0454**

€ 50,50

**REMACHADORA MANUAL CON CABEZAL MULTIPLE**

Palancas largas para trabajar sin esfuerzo, incluso con remaches de 6,4 mm. Depósito de plástico para recuperar los clavos cizallados. Con cabezal giratorio de 4 posiciones.



Remaches	Ø 3,2 - 4,0 - 4,8 - 6,4 mm
Longitud	400 mm

**0470**

€ 18,20

**REMACHADORA MANUAL CON CABEZAL MULTIPLE**

Con cabezal giratorio a 4 posiciones.



Remaches	Ø 2,4 - 3,2 - 4,0 - 4,8 mm
----------	----------------------------

**0872/P € 68,60**
**JUEGO DE ALICATES LARGAS DOBLE ARTICULACION**

Longitud	335 mm
Espesor	10 mm

**0872/PDD € 25,70**
**ALICATE LARGA DOBLE ARTICULACION BOCA PLANA**

Cr-V



Longitud	335 mm
Espesor	10 mm

**0872/PCD € 25,70**
**ALICATE LARGA DOBLE ARTICULACION BOCA EN PUNTA 45°**

Cr-V



Longitud	335 mm
Espesor	10 mm

**0872/OPD € 26,80**
**ALICATE LARGA DOBLE ARTICULACION BOCA REDONDA**

Boca ø 8mm, indicada para extracción bujías.



Cr-V



Longitud	335 mm
Espesor	10 mm

**0873-U**
**ALICATE UNIVERSAL**



Cr-V



Art.	€	Longitud	Espesor
0873/U6	€ 8,40	160 mm	11 mm
0873/U7	€ 8,90	180 mm	10,5 mm
0873/U8	€ 10,10	200 mm	12 mm

**0873-BD**
**ALICATE CON PUNTAS SEMIREDONDAS**

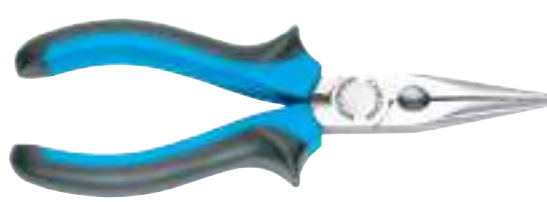
Cr-V



Art.	€	Longitud	Espesor
0873/BD6	€ 7,20	160 mm	9 mm
0873/BD8	€ 9,10	200 mm	10 mm

**0873-BC**
**ALICATE CON PUNTAS SEMIREDONDAS CORTADAS**

Cr-V



Art.	€	Longitud	Espesor
0873/BC6	€ 7,20	160 mm	9 mm
0873/BC8	€ 9,10	200 mm	10 mm

**0873/TL**
**ALICATE DE CORTE LATERAL**
**€ 7,90**

Cr-V



Longitud	160 mm
Espesor	9 mm

**0873/TF** € 10,00

**ALICATE DE CORTE FRONTAL**



Colgante

Cr-V



Cromado

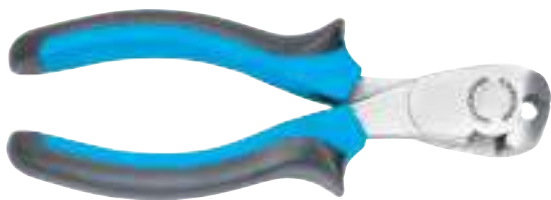

Longitud 160 mm  
Espesor 11 mm

**0020/1** € 5,40

**ALICATE PARA ELECTRONICA DE PUNTAS EXTRA LARGAS**



Blister



Acero



Cromado



Longitud 150 mm

**0020/2** € 4,03

**ALICATE PARA ELECTRONICA DE PUNTAS ACODADAS**



Blister



Acero



Cromado



Longitud 125 mm

**0020/3** € 4,39

**ALICATE PARA ELECTRONICA DE PUNTAS PLANAS**



Blister



Acero



Cromado



Longitud 125 mm

**0020/4** € 4,29

**ALICATE PARA ELECTRONICA DE PUNTAS LARGAS**



Blister



Acero



Cromado



Longitud 125 mm

**0020/5** € 4,84

**ALICATE PARA ELECTRONICA DE CORTE FRONTAL**



Blister



Acero



Cromado



Longitud 110 mm

**0020/6** € 4,67

**ALICATE PARA ELECTRONICA DE CORTE LATERAL**



Blister



Acero



Cromado



Longitud 110 mm

**0020** € 16,60

**JUEGO DE ALICATES PARA ELECTRONICA**



5 Pcs



Blister



Acero



Baquelita



Cromado

Longitud 110 + 125 mm

**08X**

**ALICATES UNIVERSALES**



Colgante



Satinado



Art.	€	Longitud	Espesor
0810	€ 5,80	160 mm	11 mm
0811	€ 7,10	180 mm	11 mm
0850	€ 7,90	200 mm	13 mm

**0812**

**€ 5,90**

**ALICATES CON PUNTAS SEMIREDONDAS**



Colgante



Satinado



Longitud	160 mm
Espesor	10 mm

**0813**

**€ 6,40**

**ALICATES CON PUNTAS SEMIREDONDAS CORTADAS**



Colgante



Satinado



Longitud	160 mm
Espesor	10 mm

**0814**

**€ 5,40**

**ALICATE DE CORTE LATERAL**



Colgante



Satinado



Longitud	160 mm
Espesor	10 mm

**0841**

**€ 22,80**

**ALICATES A CARRACA**

Con gatillo de bloqueo.



Blister



Acero



Para terminales preaislados	Ø 0,8 + 3,5 mm / 0,25 ÷ 6 mm <sup>2</sup> AWG 22-10
Longitud	230 mm
Espesor	12 mm

**0843**

**€ 23,70**

**ALICATES A CARRACA**

Con gatillo de bloqueo.



Blister



Acero



Para terminales no aislados	Ø 1 + 3,5 mm / 0,5 ÷ 6 mm <sup>2</sup> AWG 20-10
Longitud	230 mm
Espesor	12 mm

**0847**

**€ 74,30**

**ALICATE A CARRACA**

Con gatillo de bloqueo.



Blister



Acero



Satinado



Terminales	0,25 ÷ 6 mm <sup>2</sup> AWG 23-10
Longitud	175 mm
Espesor	12 mm

**0628**

**€ 18,00**

**ALICATE PARA JUNTAS**

Con boton de des-bloqueo.



Blister



Acero



Conectores	RJ-11 (6P4C); RJ-12 (6P6C); RJ-45 (8P8C)
------------	--

**0826** € 29,10

**ALICATE PARA TERMINALES Y PELACABLES**

Alicate para terminales pequeños para coche y ordenador y pelacables para cables finos.



Blister



Acero



Longitud	215 mm
Terminales	AWG 30-26 - AWG 24-20 - AWG 18-14
Capacidad de corte	Ø 0,25 - 0,3 - 0,4 - 0,5 - 0,65 - 0,8 - 1,0 mm AWG30 - AWG28 - AWG26 - AWG24 - AWG22 - AWG20 - AWG18

**0122** € 9,80

**KIT DE ALICATE PARA TERMINALES**

Con terminales aislados.



Blister



Acero



Longitud	220 mm
----------	--------

**024XE**

**ALICATES PARA ANILLOS DE SEGURIDAD "SEEGER"**

Recta para exteriores.



Colgante



Cr-V



Art.	€	Arandelas de seguridad	Longitud
0246	€ 11,30	Ø 19 ÷ 60 mm	185 mm
0636	€ 9,60	Ø 10 ÷ 25 mm	160 mm
0674	€ 8,60	Ø 3 ÷ 10 mm	150 mm
0676	€ 10,90	Ø 32 ÷ 80 mm	225 mm

**024XI**

**ALICATES PARA ANILLOS DE SEGURIDAD "SEEGER"**

Recta para interiores.



Colgante



Cr-V



Art.	€	Arandelas de seguridad	Longitud
0248	€ 11,30	Ø 19 ÷ 60 mm	175 mm
0638	€ 9,60	Ø 8 ÷ 25 mm	150 mm
0619	€ 8,60	Ø 3 ÷ 10 mm	135 mm
0631	€ 10,90	Ø 32 ÷ 80 mm	225 mm

**063XE**

**ALICATES PARA ANILLOS DE SEGURIDAD "SEEGER"**

Curva para exteriores.



Colgante



Cr-V



Art.	€	Arandelas de seguridad	Longitud
0247	€ 11,30	Ø 19 ÷ 60 mm	175 mm
0637	€ 9,60	Ø 10 ÷ 25 mm	150 mm
0108	€ 8,60	Ø 3 ÷ 10 mm	135 mm
0324	€ 10,90	Ø 32 ÷ 80 mm	215 mm

**063XI**

**ALICATES PARA ANILLOS DE SEGURIDAD "SEEGER"**

Curva para interiores.



Colgante



Cr-V



Art.	€	Arandelas de seguridad	Longitud
0249	€ 11,30	Ø 19 ÷ 60 mm	165 mm
0639	€ 9,60	Ø 8 ÷ 25 mm	150 mm
0340	€ 8,60	Ø 3 ÷ 10 mm	135 mm
0364	€ 10,90	Ø 32 ÷ 80 mm	215 mm

**0136** € 23,90

**JUEGO DE ALICATES DE NYLON**

Para coche.



3 Pcs



Blister



Nylon



Longitud	158 - 185 - 254 mm
Diámetro tubo	10 - 15 - 24 mm

**0603** € 102,00

**JUEGO DE ALICATES PARA ABRAZADERAS DE COCHE**



9 Pcs



Estuche de transporte



Acero



**0118** € 4,99

**ALICATE PICO DE LORO**

6 posiciones.



Acero

Longitud 240 mm

**0831-**
**ALICATE PICO DE LORO**

7 posiciones.



Colgante

Cr-V



8976/C

Art.	€	Longitud
0831/175	€ 8,10	175 mm
0831/250	€ 9,60	250 mm
0831/300	€ 11,80	300 mm

**0834-**
**TENAZA RUSA**

Colgante



Acero



9242

Art.	€	Longitud
0834	€ 5,80	220 mm
0834/200	€ 4,89	200 mm
0834/250	€ 6,10	250 mm
0834/280	€ 7,70	280 mm

**0206**

€ 6,80

**TENAZA CARPINTERO**

Colgante



Acero

Longitud 200 mm

**0121**

€ 24,90

**PINZA MORDAZA CON GRIP**

Caja



Acero



Satinado

 Longitud 230 mm  
 Regulable 0 ÷ 155 mm

**0120**

€ 9,80

**PINZA MORDAZA DE 4 POSICIONES**

Caja



Acero



Satinado

 Longitud 230 mm  
 Apertura 18 - 39 - 43 mm

**0119-**
**PINZA MORDAZA**

Blister



Acero



Satinado

Art.	€	Longitud
0119/5	€ 5,00	130 mm
0119/7	€ 6,00	180 mm
0119	€ 7,10	220 mm

**0379**

€ 12,20

**PINZA MORDAZA DE SOLDADOR**

Caja



Acero



Satinado

Longitud 225 mm

0368-

**PINZA MORDAZA AUTOMATICO**



Art.	€	Longitud
0368/7	€ 27,50	160 mm
0368/10	€ 35,20	230 mm

0370/11

€ 42,70

**PINZA MORDAZA AUTOMATICO CON NARIZ LARGA**



Longitud	275 mm
----------	--------

0373-

**SARGENTO GRIP AUTOMATICO CON OSCILANTE**



Art.	€	Longitud	Apertura
0373/9	€ 34,30	210 mm	65 mm
0373/11	€ 41,50	300 mm	95 mm

0130-

**GIRATUBO**



Cr-V

Art.	€	Dimensiones	Apertura máx.
0130/350	€ 15,90	350 mm - 14"	50 mm
0130/600	€ 24,50	600 mm - 24"	90 mm

0225-

**GIRATUBO 45°**



Cr-V

Art.	€	Dimensiones	Apertura máx.
0225/340	€ 20,10	340 mm - 1"	46 mm
0225/440	€ 30,10	440 mm - 1,5"	62 mm
0225/580	€ 37,40	580 mm - 2"	72 mm
0225/700	€ 50,80	700 mm - 3"	100 mm

0227-

**GIRATUBO 90°**



Cr-V

Art.	€	Dimensiones	Apertura máx.
0227/340	€ 20,10	330 mm - 1"	38 mm
0227/440	€ 28,70	415 mm - 1,5"	52 mm
0227/580	€ 41,50	580 mm - 2"	75 mm
0227/700	€ 56,50	700 mm - 3"	100 mm

**0511** € 37,90

**MAZA**

Con mango de seguridad en fibra de vidrio y plástico, revestido de goma antideslizante.



Fibra de vidrio

Longitud	820 mm
Peso del cabezal	3,50 kg
Peso neto	4,45 kg

**0781** € 12,80

**MACETA CUADRADA**

Con mango de seguridad en fibra de vidrio y plástico, cubierto con goma antideslizante.



Fibra de vidrio



6475

Longitud	260 mm
Peso neto	1000 g

**0780** € 10,10

**MARTILLO PARA CARPINTERO**

Con mango de seguridad en fibra de vidrio y plástico, cubierto con goma antideslizante.



Fibra de vidrio

Peso neto	500 g
-----------	-------

**0514-**
**MARTILLO TIPO ALEMANO**

Con mango de seguridad en fibra de vidrio y plástico, cubierto con goma antideslizante.



Fibra de vidrio



1041

Art.	€	Peso neto
0514/200	€ 5,40	200 g
0514/300	€ 6,60	300 g
0514/400	€ 7,90	400 g
0514/500	€ 9,50	500 g
0514/1000	€ 14,10	1000 g

**0154-**
**MARTILLO TIPO ALEMANO**

Madera



1041

Art.	€	Peso neto
0154/100DIN	€ 2,84	100 g
0154/200DIN	€ 4,02	200 g
0154/300DIN	€ 4,22	300 g
0154/400DIN	€ 5,60	400 g
0154/500DIN	€ 5,90	500 g
0154/600DIN	€ 6,50	600 g
0154/800DIN	€ 7,20	800 g
0154/1000DIN	€ 10,70	1000 g
0154/1500DIN	€ 11,90	1500 g
0154/2000DIN	€ 15,10	2000 g

**0153-**
**MACETA CUADRADA**

Madera



6475

Art.	€	Peso neto
0153/800DIN	€ 7,20	800 g
0153/1000DIN	€ 8,00	1000 g
0153/1250DIN	€ 9,80	1250 g
0153/1500DIN	€ 11,30	1500 g

0169-

**MARTILLO PARA CARPINTERO**

Con porta clavo magnetico.



Madera

Art.	€	Peso neto
0169/300	€ 7,20	300 g
0169/400	€ 8,70	400 g

0216/400

€ 8,40

**DECINTROIR PANNE/HACHE**

Decintroir panne/hache.



Madera

Longitud del mango	380 mm
Peso neto	400 g

0239/400

€ 10,40

**DECINTROIR PANNE/HACHE**

Decintroir panne/hache.



Fibra de vidrio

Longitud del mango	380 mm
Peso neto	400 g

0148/500

€ 4,33

**MAZA DE GOMA**



Madera

Cabezal	Ø 65 mm
Peso neto	500 g

0243-

**MAZA DE GOMA Y FIBRA**



Acero

Art.	€	Cabezal	Peso neto
0243/30	€ 5,70	Ø 30 mm	350 g
0243/40	€ 8,00	Ø 40 mm	500 g

0794-

**MAZA DE GOMA**

Con mango de fibra de vidrio.



Fibra de vidrio

Art.	€	Cabezal	Peso neto
0794/350	€ 5,80	Ø 55 mm	350 g
0794/450	€ 8,10	Ø 58 mm	500 g

**0808-**
**MARTILLO**

De aluminio con mango anatomico y cabezas de polietileno.



Madera

Art.	€	Cabezal	Peso neto
0808/35	€ 19,10	Ø 35 mm	350 g
0808/60	€ 45,40	Ø 60 mm	800 g

**033X**
**MAZA ANTIREBOTE**

Art.	€	Cabezal	Peso neto	Dureza
0336	€ 12,50	Ø 45 mm	500 g	90ah
0337	€ 14,10	Ø 50 mm	900 g	90ah

**0840-**
**MAZA ANTIREBOTE**

Tacos de nylon indeformable.



made in italy

Art.	€	Cabezal	Peso neto
0840/40	€ 52,60	Ø 40 mm	750 g
0840/50	€ 61,20	Ø 50 mm	1000 g
0840/60	€ 68,60	Ø 60 mm	1500 g

**0840-XT**
**CABEZA DE REPUESTO**

Para maza antirebote 0840-.



made in italy

Art.	€	Cabezal
0840/40T	€ 12,40	Ø 40 mm
0840/50T	€ 12,40	Ø 50 mm
0840/60T	€ 18,10	Ø 60 mm

**G009**
**€ 16,60**
**CABLE DE SEGURIDAD PARA HERRAMIENTAS**

Cable espiral con ganchos para evitar la caída de las herramientas cuando se trabaja en alturas.

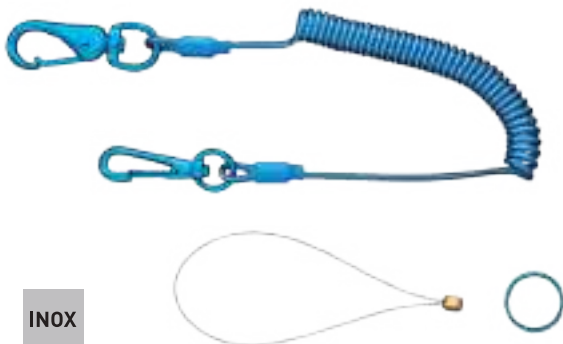

Blister

**INOX**

Capacidad	5 kg
Longitud	430 ÷ 1600 mm



**B006-**

**GRANETE**

Con cuerpo octagonal.



Cr-Mo



7250

Art.	€	Medidas	Longitud
B006/4	€ 4,15	4 mm	120 mm
B006/5	€ 5,70	5 mm	150 mm

**S022-**

**CINCEL PARA METAL**



Cr-Mo

Art.	€	Dimensiones	Longitud
S022/18	€ 8,40	18 mm	150 mm
S022/21	€ 11,40	21 mm	200 mm
S022/25	€ 15,50	25 mm	250 mm
S022/26	€ 15,10	26 mm	240 mm

**C012-**

**BOTADOR**

Con cuerpo octagonal.



Cr-Mo

Art.	€	Dimensiones	Longitud
C012/02	€ 4,78	Ø 2 mm	150 mm
C012/03	€ 4,78	Ø 3 mm	150 mm
C012/04	€ 4,78	Ø 4 mm	150 mm
C012/05	€ 5,40	Ø 5 mm	150 mm
C012/06	€ 5,90	Ø 6 mm	150 mm
C012/08	€ 6,50	Ø 8 mm	150 mm

**C015-**

**BOTADOR**

Con cuerpo octagonal y paramano.



Colgante



Cr-Mo



Cromado

Art.	€	Medida	Longitud
C015/2	€ 7,50	Ø 2 x 8 mm	140 mm
C015/3	€ 7,90	Ø 3 x 8 mm	150 mm
C015/4	€ 8,50	Ø 4 x 10 mm	180 mm
C015/5	€ 8,80	Ø 5 x 10 mm	220 mm
C015/6	€ 10,40	Ø 6 x 12 mm	210 mm
C015/7	€ 10,40	Ø 7 x 12 mm	210 mm

**C015**

€ 63,20

**JUEGO DE BOTADORES**

Con cuerpo octagonal y paramano.



6 Pcs



Colgante



Cr-Mo



Cromado

Medidas

Ø 2 - 3 - 4 - 5 - 6 - 7 - 8 mm

**0126**

€ 14,60

**JUEGO DE BOTADORES CON SOPORTE DE PLASTICO**



6 Pcs



Blister



Cr-V

Dimensiones

Ø 3-4-5-6-8-10 mm

Longitud

150 mm

**0127**

€ 15,20

**JUEGO DE CINCELES, PUNZONES Y GRANETE CON SOPORTE DE PLASTICO**



6 Pcs



Blister



Cr-V

Longitud

120 - 150 mm

**0396**

€ 13,20

**JUEGO DE FORMONES PARA HIERRO**



3 Pcs



Colgante



Cr-V

Dimensiones

10 x 8 x 140 mm, 13 x 9,5 x 150 mm, 16 x 12 x 170 mm

**0381** € 8,70

**GRANETE AUTOMÁTICO**

Muelle.



Longitud 125 mm

**0733** € 10,00

**GRANETE AUTOMÁTICO**

Con muelle. Posibilidad de ajustar la profundidad de punzonado.



Longitud 140 mm

**0734-**
**MARCADORES DE AGUJEROS**

Para centrar dentro de orificios existentes, la parte frontal cónica accionada por resorte proporciona un centrado preciso.

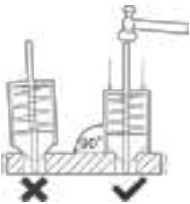

Art.	€	Longitud	Díámetro del agujero
0734/1	€ 8,00	82 mm	Ø5 ÷ Ø15 mm
0734/2	€ 13,00	100 mm	Ø5 ÷ Ø30 mm

**0391** € 32,40

**JUEGO DE CINCELES, PUNZONES Y GRANETES CON PARAMANO**

Cr-V



Cinceles	10 x 135 mm, 13 x 150 mm, 16 x 160 mm
Granetes	04 x 130 mm
Punzón plano cónico	03 x 120 mm
Punzón plano cilíndrico	03 x 120 mm

**0258** € 4,33

**FORMÓN DE CORTE CON PARAMANO**

Dimensiones 16 x 300 mm

**0259** € 4,15

**FORMÓN DE PUNTERO CON PARAMANO**

Dimensiones 16 x 300 mm



**0300** € 18,70

**JUEGO DE FORMONES PARA MADERA**



Dureza HRC 58-60  
Dimensiones 10-16-20-25 mm

**0301-**  
**FORMONES PARA MADERA**

Dureza HRC 58-60.



Art.	€	Dimensiones
0301/06	€ 4,48	6 mm
0301/10	€ 4,48	10 mm
0301/16	€ 5,40	16 mm
0301/20	€ 5,40	18,5 mm
0301/24	€ 6,50	25 mm

**0168** € 11,00

**JUEGO DE FORMONES PARA MADERA**



Dureza HRC 58-60  
Medidas 240 x 6-10-16-20-24 mm

**0306** € 62,80

**JUEGO DE CINCELES DE CORTE**

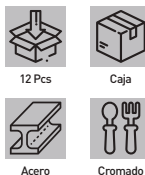

Dureza HRC 58-60  
Longitud 215 mm

**0162** € 18,50

**JUEGO DE CINCELES PARA MADERA**



Dureza HRC 58-60  
Longitud total 370 mm

**0166** € 19,70

**CEPILLO METALICO PARA MADERA**



Longitud gartopa 225 mm  
Anchura hoja 50 mm

**0519** € 5,70

**JUEGO DE LIMAS PARA MADERA CON MANGO DE PLASTICO**



Dimensiones 200 mm - 8"

**0160** € 17,40

**JUEGO DE LIMAS PARA HIERRO CON EMPUNADURA ANATOMICA**

5 piezas: 1 plana, 1 cuadrada, 1 triangular, 1 redonda, 1 media caña.



Dimensiones 200 mm - 8"

**0219** € 5,60

**JUEGO DE LIMAS**

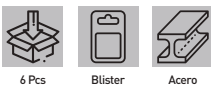

Longitud total 180 mm

**L012** € 34,90

**JUEGO DE LIMAS DIAMANTADAS**



Longitud 180 mm

**L013** € 22,80

**JUEGO DE LIMAS DIAMANTADAS**



Longitud 140 mm

**L012/PIA** € 9,60

**LIMA PLANA DIAMANTADA**



Longitud 180 mm

**0737-**

**LIMAS PARA MECANICA**

Forma rectangular, con mango anatomico, antideslizante.

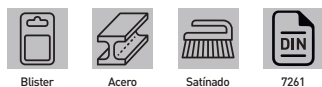

Art.	€	Corte	Dimensiones	Pack
0737/150T2	€ 4,86	Limas extrafinas	150 mm / 6"	10
0737/150T3	€ 4,86	Dolce	150 mm / 6"	10
0737/200T2	€ 5,80	Limas extrafinas	200 mm / 8"	10
0737/200T3	€ 5,80	Limas finas	200 mm / 8"	10
0737/250T2	€ 7,10	Limas finas	250 mm / 10"	10
0737/250T3	€ 7,10	Limas extrafinas	250 mm / 10"	10

**0738-**

**LIMAS PARA MECANICA**

Forma triangular. Con mango anatomico, antideslizante.



Art.	€	Corte	Dimensiones	Pack
0738/150T2	€ 4,86	Limas extrafinas	150 mm / 6"	10
0738/150T3	€ 4,86	Limas finas	150 mm / 6"	10
0738/200T2	€ 5,80	Limas extrafinas	200 mm / 8"	10
0738/200T3	€ 5,80	Limas finas	200 mm / 8"	10
0738/250T2	€ 7,10	Limas extrafinas	250 mm / 10"	10
0738/250T3	€ 7,10	Limas finas	250 mm / 10"	10

**0739-**

**LIMAS PARA MECANICA**

Forma media cana. Con mango anatomico, antideslizante.

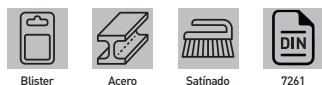

Art.	€	Corte	Dimensiones	Pack
0739/150T2	€ 4,86	Limas extrafinas	150 mm / 6"	10
0739/150T3	€ 4,86	Limas finas	150 mm / 6"	10
0739/200T2	€ 5,80	Limas extrafinas	200 mm / 8"	10
0739/200T3	€ 5,80	Limas finas	200 mm / 8"	10
0739/250T2	€ 7,10	Limas extrafinas	250 mm / 10"	10
0739/250T3	€ 7,10	Limas finas	250 mm / 10"	10

**0740-**

**LIMAS PARA MECANICA**

Forma redonda. Con mango anatomico, antideslizante.



Art.	€	Corte	Dimensiones	Pack
0740/150T2	€ 4,86	Limas extrafinas	150 mm / 6"	10
0740/150T3	€ 4,86	Limas finas	150 mm / 6"	10
0740/200T2	€ 5,80	Limas extrafinas	200 mm / 8"	10
0740/200T3	€ 5,80	Limas finas	200 mm / 8"	10
0740/250T2	€ 7,10	Limas extrafinas	250 mm / 10"	10
0740/250T3	€ 7,10	Limas finas	250 mm / 10"	10

**0741-**

**LIMAS PARA MECANICA**

Forma cuadrada. Con mango anatomico, antideslizante.

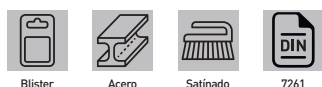

Art.	€	Corte	Dimensiones	Pack
0741/150T2	€ 4,86	Limas extrafinas	150 mm / 6"	10
0741/150T3	€ 4,86	Limas finas	150 mm / 6"	10
0741/200T2	€ 5,80	Limas extrafinas	200 mm / 8"	10
0741/200T3	€ 5,80	Limas finas	200 mm / 8"	10
0741/250T2	€ 7,10	Limas extrafinas	250 mm / 10"	10
0741/250T3	€ 7,10	Limas finas	250 mm / 10"	10

**0742-**

**EMPUÑADURA ANATÓMICA ANTIDESLIZANTE**



Art.	€	Para lima	Pack
0742/4	€ 1,40	100 mm - 150 mm / 4" - 6"	12
0742/6	€ 1,40	150 mm - 250 mm / 6" - 10"	12
0742/10	€ 1,60	250 mm - 400 mm / 10" - 16"	12

**0202 € 36,50**
**SET 4 UNDS. PALANCAS**

4 Pcs



Blister



Acero

**Dimensiones** 230mm/9" - 300mm/12" - 450mm/18" - 590mm/24"

**0320 € 6,60**
**PATA DE CABRA**

Acero

**Longitud total** 600 mm  
**Hexágono** 15,6 mm

**0192 € 147,00**
**SET PALANCAS**

1 palanca recta de 910mm/36", 1 curva a 45° 910mm/36", 1 curva a 60° 610mm/24" y 1 curva a 90° 610 mm/24".



4 Pcs



Estuche de transporte

Cr-V

**0198 € 6,10**
**BARRAS DE LEVAR Y MONTAR**

Acero

**Longitud** 400 mm  
**A** 30 mm  
**B** 23 mm  
**Pack** 5

**L007 € 7,50**
**PALANCA PARA NEUMÁTICOS**

Caja



Acero



Satinado

**Dimensiones** 215 x 16 x 5 mm

**0267 € 9,60**
**PALANCA PARA NEUMATICOS**

Caja



Acero



Satinado

**Dimensiones** 510 x 26 x 9 mm



**0623** € 5,40

**CUTTER CON CUCHILLA DE ACERO, CUCHILLAS DE REPUESTO INCLUIDAS**

Con carga automática de la hoja.



Hojas incluidas 3  
Anchura hoja 18 mm

**0627** € 4,15

**CUTTER CON CUCHILLA DE ACERO, CUCHILLAS DE REPUESTO INCLUIDAS**

Con carga automática de la hoja.



Hojas incluidas 5  
Anchura hoja 9 mm

**0617** € 2,61

**CUTTER CON CUCHILLA DE ACERO, CUCHILLAS DE REPUESTO INCLUIDAS**

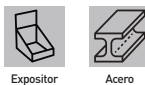

Hojas incluidas 3  
Anchura hoja 18 mm

**0613** € 2,08

**CUTTER CON CUCHILLA DE ACERO, CUCHILLAS DE REPUESTO INCLUIDAS**

ISO 9001.



Hojas incluidas 3  
Anchura hoja 9 mm

**0096** € 2,61

**CUTTER CON CUCHILLA EN ACERO, CUCHILLAS DE REPUESTO INCLUIDAS**



Hojas incluidas 3  
Anchura hoja 18 mm

**0612** € 3,12

**CUTTER CON CUCHILLA DE ACERO, CUCHILLAS DE REPUESTO INCLUIDAS**



Hojas incluidas 3  
Anchura hoja 9 mm



**0611** € 2,91

**CUTTER CON CUCHILLA DE ACERO, CUCHILLAS DE REPUESTO INCLUIDAS**



Hojas incluidas 3  
Anchura hoja 9 mm

**0035** € 6,50

**CUTTER DE SEGURIDAD, CUCHILLAS INCLUIDAS**

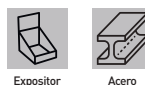

Hojas incluidas 4  
Hoja trapezoidal 19 x 61 x 0,6 mm

**0792** € 10,70

**CUTTER AUTOMATICO DE PLASTICO CON CUCHILLA RETRACTIL DE ACERO, CUCHILLAS INCLUIDAS**



Hojas incluidas 5  
Anchura hoja 25 mm

**0696** € 8,00

**CUTTER DOBLABLE, CUCHILLAS INCLUIDAS**



Hojas incluidas 5  
Anchura hoja 20 mm

**0095** € 1,72

**JUEGO DE CUTTERS**



**0696/L** € 1,97

**SET CUCHILLAS PARA CUTTERS**



Hoja trapezoidal 19 x 61 x 0,6 mm



**0627/L** € 2,15

**CUCHILLAS PARA CUTTERS**

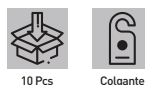

Anchura hoja 9 mm





**0096/L** € 2,15

**SET CUCHILLAS PARA CUTTERS**



10 Pcs Colgante Acero

Anchura hoja 18 mm



**0792/L** € 8,20

**SET CUCHILLAS PARA CUTTERS**



10 Pcs Colgante Acero

Anchura hoja 25 mm



**0420** € 7,20

**DESBARBADOR CON 1 CUCHILLA**



Blister

Longitud 120 mm  
Diámetro máximo mango 9,2 mm  
Hoja E100 - Ø 3,2 mm  
Material hoja HSS

**0411** € 14,10

**DESBARBADOR CON 1 CUCHILLA**



Caja

Longitud 124 mm  
Diámetro máximo mango 29 mm  
Hoja E100 - Ø 3,2 mm  
Material hoja HSS

**0415** € 9,60

**DESBARBADOR CON 2 CUCHILLAS**



3 Pcs

Blister

Longitud 125 mm  
Diámetro máximo mango 22 mm  
Hoja E100 - E200 - Ø 3,2 mm  
Material hoja HSS



**S002** € 15,20

**DESBARBADOR EXTENSIBLE A 3 CUCHILLAS**



4 Pcs

Caja

HSS

Hoja Ø 3,2 mm  
Dimensiones hoja E100 - E200 - E300

**0420/S** € 22,30

**JUEGO DE DESBARBADORES CON CUCHILLA**

Para desbarbado interior y exterior de materiales duros y blandos. Cómodos y prácticos equipados con clips para llevarlos siempre contigo y tenerlos disponibles en el momento adecuado. Con mango ergonómico y de diferentes colores para identificar inmediatamente el desbarbador adecuado para el material adecuado: morado para aluminio, rojo para latón y hierro fundido, azul para acero y amarillo para plástico



4 Pcs

Blister

HSS

Plastic

Longitud 120 mm  
Hoja Ø 3,2 mm

**S002/E100** € 15,10

**SET DE CUCHILLAS HSS DE MANGO LARGO**

Para el desbarbado interno y externo de materiales de viruta larga como el acero, el aluminio y los materiales plásticos.



10 Pcs

Colgante

HSS



**S002/E200** € 14,10

**SET DE CUCHILLAS HSS BIDIRECCIONAL**

Para el desbarbado interno y externo de materiales de viruta corta como el latón y la fundición.



10 Pcs

Colgante

HSS



**S002/E300** € 15,10

**SET DE CUCHILLAS HSS BIDIRECCIONAL**

Para el desbarbado interior y exterior de agujeros hasta 4mm de grosor.



10 Pcs

Colgante

HSS



**S005 € 14,20**
**DESBARBADOR DOBLE CON RUEDAS EN HSS**

Para desburrado de hojas de acero, aluminio, latón, cobre y plástico máx. 10mm.

**S005/R € 15,90**
**JUEGO DE RUEDAS**

**0384 € 6,50**
**DESBARBADOR INTERNO Y EXTERNO POR TUBOS**

Para cobre y metales ferrosos.

**Capacidad** 3 ÷ 32 mm 3/16" ÷ 1-1/2"

**0647/25 € 17,40**
**RASPADOR CON CUCHILLA DE METAL DURO DE 25MM DE TRES CORTANTES**

**0647/50 € 18,20**
**RASPADOR CON CUCHILLA DE METAL DURO DE 50MM DE DOS CORTANTES**

**0647/65 € 19,80**
**RASPADOR CON CUCHILLA DE METAL DURO DE 65MM DE DOS CORTANTES**

**0647/25L € 14,20**
**SET 2 PZ CHUCHILLAS DE REPUESTO**

**0647/50L € 14,50**
**SET 2 PZ CHUCHILLAS DE REPUESTO**

**0647/65L € 14,50**
**SET 2 PZ CHUCHILLAS DE REPUESTO**



0869

€ 15,10

**SERRUCHO DE CARPINTERO**



Acero

Longitud hoja 400 mm

0226

€ 9,50

**ARCO DE SIERRA CON EMPUNADURA DE ALUMINIO**

Empuñadura suplementaria para cortes pequeños y agujeros. Hoja bimetálica y cuerpo en aluminio.

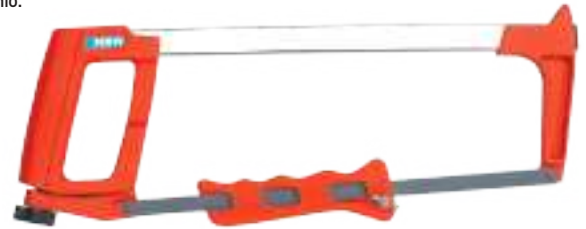

Alu

Aluminio

Longitud hoja 310 mm

0629

€ 20,80

**ARCO DE SIERRA CON CUCHILLA**

Hoja bimetálica y cuerpo en aluminio.



Alu

Aluminio

Longitud hoja 300 mm

0161

€ 3,98

**SIERRA PEQUENA CON CUCHILLA**



Alu

Aluminio

Longitud hoja 150 mm

0724/B

€ 2,00

**HOJA BIMETALICA**

ISO 2336-1.



Caja

HSS

Medidas 300 x 12,7 x 0,62 mm x 24T - 12" x 1/2" x 0,025" x 24T  
Pack 10

0159

€ 0,29

**HOJA DE ACERO**

ISO 2336-1.



Caja

Medidas 300 x 12,7 x 0,62 mm x 24T - 12" x 1/2" x 0,025" x 24T  
Pack 100

0670

€ 53,80

**ROEDORA PARA TALADRO**

De doble cabeza con accesorio para cortes derechos y circulares.

0670/U

€ 14,20

**SET DE HERRAMIENTAS DE REPUESTO**



Caja

HSS

TiN

Capacidad de corte  
chapas de hierro 1,8 mm  
Chapas de acero inox. 1,2 mm  
chapas de cobre y aluminio 2,0 mm



materiales plásticos 2,0 mm  
Velocidad de rotación 1500 ÷ 3000 rpm  
Collar Ø 43,2 mm  
Cajón de metal



**0655/L € 9,90**

**CIZALLA IZQUIERDA PARA CHAPAS**

Las cuchillas están endurecidas y mango de forma ergonómica.



Blister



Cr-V



Cromado

Longitud 245 mm  
Dureza 50 - 52 HRC

**0655/S € 9,90**

**CIZALLA RECTA PARA CHAPAS**

Las cuchillas están endurecidas y mango de forma ergonómica.



Blister



Cr-V



Cromado

Longitud 245 mm  
Dureza 50 - 52 HRC

**0655/R € 9,90**

**CIZALLA DERECHA PARA CHAPAS**

Las cuchillas están endurecidas y mango de forma ergonómica.



Blister



Cr-V



Cromado

Longitud 245 mm  
Dureza 50 - 52 HRC

**0699/240 € 6,50**

**TIJERAS DE ACERO INOX**

Con mango de nylon.



Blister

**INOX**



Satinado

Longitud 240 mm

**0672 € 7,90**

**TIJERA DE ELECTRICISTA**

Lama de corte micro dentada y mango ergonomico en abs.



Blister

**INOX**



Satinado

Longitud 5" 1/2 - 140 mm

**0672/B € 10,70**

**TIJERA DE ELECTRICISTA**

Lama de corte micro dentada y mango bicolor anti deslizante.



Blister

**INOX**



Satinado

Longitud 140 mm

**0141 € 11,70**

**TIJERA DE ELECTRICISTA**



Blister

**INOX**



Satinado

Longitud 5" 1/2 - 140 mm

**F018 € 27,10**

**TIJERA DE ELECTRICISTA**

1000V IEC 60900, con hoja de afeitar microdentada, mango ergonómico en ABS.



Blister

**INOX**



Satinado

Longitud 6" - 160 mm

**0673 € 10,70**

**TIJERA MULTIUSO**

Lama de corte micro dentada y mango bicolor anti deslizante en plastic y goma.



Blister

**INOX**



Satinado

Longitud 175 mm / 7" mm



**0325** € 13,90

**TIJERA MULTIUSO**

Hoja de corte micro dentada y mango bicolor anti deslizante.



Longitud 210 mm / 8" mm

**0424** € 12,80

**SACABOCADOS DE REVOLVER**

Permite hacer agujeros pequeños en materiales con espesor pequeño como: papel, cartón, goma y cuero.



Longitud 250 mm

**0081** € 32,90

**JUEGO DE SACABOCADOS**



Medidas Ø 5 - 6 - 8 - 10 - 12,5 - 16 - 20 - 25 - 32 mm

**0093/22** € 5,90

**MINI CORTATUBOS POR COBRE Y PLASTICO**

Con cuerpo de aleación de zinc.



Capacidad de corte 3÷22 mm , 1/8"÷7/8"

**0093/42** € 23,30

**MINI CORTATUBOS POR COBRE Y HIERRO**

Con cuerpo de aleación de aluminio.



Capacidad de corte 6÷42 mm , 15 / 64" ÷ 1-21 / 32"  
Dureza HRC 58-60

**0092** € 6,50

**CORTATUBO PARA TUBOS DE COBRE**



Capacidad 3 + 28 mm - 1/8" ÷ 1 1/8"

**0472** € 18,70

**ABOCINADORES PARA COBRE Y ALUMINIO**



Tubo redondo 5 - 6 - 8 - 10 - 12 - 14 - 16 mm

**0253** € 10,10

**CORTATUBO PARA POLIURETANO Y GOMA**

Apto para cortar tubos de pe, pu y goma. Mango de dos componentes.



Apertura máx. 19 mm  
Longitud 133 mm

**0287-**
**CORTAPERNOS**

Ideal para cortar varillas de hierro, cadenas y un gran tipo de materiales ferrosos y no ferrosos.



Cr-V

Art.	€	Dimensiones
0287/300	€ 16,90	300 mm - 12"
0287/350	€ 19,30	350 mm - 14"
0287/450	€ 24,70	450 mm - 18"
0287/600	€ 31,20	600 mm - 24"
0287/750	€ 40,40	750 mm - 30"

**0846/150**
**€ 122,00**
**CORTACABLES MANUAL**

Para cable eléctrico.



Caja



Acero

 Capacidad de corte  
Longitud

 150 mm<sup>2</sup> (Al - Cu)  
250 mm

**0862**
**€ 7,20**
**ALICATE PELACABLES AUTOMÁTICO**

Blister



Acero

Corte máximo

 Ø 0,8 ÷ 3,5mm 0,25 ÷ 6 mm<sup>2</sup>
**0101/500**
**€ 9,30**
**HACHA CON MANGO DE MADERA**

Madera

**0513**
**€ 11,90**
**HACHA CON MANGO DE FIBRA DE VIDRIO**

Fibra de vidrio

**0515**
**€ 27,10**
**HACHA CON MANGO DE FIBRA DE VIDRIO**

Fibra de vidrio

Longitud 900 mm

**0322**
**€ 46,70**
**TIJERAS DE DESRAMAR A CARRACA CON LAMINAS TEMPLADAS REVESTIDAS DE TEFLON**

Mango ergonómico y antideslizante.



Colgante



Acero



Templado

Longitud

690 - 1030 mm



**0587-  
GRAPAS METALICAS**



5000 Pcs

Caja



Art.	€	Juego	Medida
0587/8006	€ 7,20	80	12,9 x 6h mm
0587/8008	€ 8,40	80	12,9 x 8h mm
0587/8010	€ 9,10	80	12,9 x 10h mm
0587/8012	€ 10,00	80	12,9 x 12h mm
0587/8014	€ 10,70	80	12,9 x 14h mm
0587/8016	€ 11,70	80	12,9 x 16h mm

**0584-  
CLAVOS**



5000 Pcs

Caja



Art.	€	Juego	Medida
0584/F10	€ 7,20	TI-PIN	1 x 10h mm
0584/F15	€ 8,40	TI-PIN	1 x 15h mm
0584/F20	€ 10,70	TI-PIN	1 x 20h mm
0584/F25	€ 11,40	TI-PIN	1 x 25h mm
0584/F30	€ 12,80	TI-PIN	1 x 30h mm
0584/F35	€ 14,10	TI-PIN	1 x 35h mm
0584/F40	€ 15,90	TI-PIN	1 x 40h mm
0584/F45	€ 16,10	TI-PIN	1 x 45h mm
0584/F50	€ 16,40	TI-PIN	1 x 50h mm

**0151 € 3,14  
GRAPAS**



500 Pcs

Blister



Sección 0,58 x 1,2 mm

**0295 € 11,30  
SURTIDO DE REMACHES**

25 Pz 2.4x6.4 mm; 25 Pz 2.4x8 mm;  
25 Pz 3.2x5 mm; 25 Pz 3.2x6.4 mm;  
25 Pz 3.2x8 mm; 25 Pz 4x6.4 mm; 25  
Pz 4x8 mm; 25 Pz 4.8x6.4 mm; 25 Pz  
4.8x8 mm.



225 Pcs

Caja

Alu  
Aluminio

**0585-  
GRAPAS METALICAS**



2500 Pcs

Caja



Art.	€	Juego	Medida
0585/9013	€ 7,40	90	5,7 x 13h mm
0585/9019	€ 10,40	90	5,7 x 19h mm
0585/9032	€ 13,10	90	5,7 x 32h mm
0585/9040	€ 14,10	90	5,7 x 40h mm

**0588-  
AGUJAS**



10000 Pcs

Caja



Art.	€	Juego	Medida
0588/615	€ 7,90	0,60	0,63 x 15h mm
0588/620	€ 9,80	0,60	0,63 x 20h mm
0588/625	€ 11,40	0,60	0,63 x 25h mm
0588/630	€ 12,90	0,60	0,63 x 30h mm
0588/635	€ 14,90	0,60	0,63 x 35h mm



**0376/AC € 10,40  
TUERCAS REMACHABLES DE ACERO**

Al carbono, tropicalizados, M3: 40 Pz -  
M4: 40 Pz - M5: 30 Pz - M6: 20 Pz - M8:  
10 Pz - M10: 5 Pz - M12: 5 Pz.



150 Pcs

Colgante



Acero



Galvanizado

Tuercas removibles M3 - M4 - M5 - M6 - M8 - M10 - M12

**0376/AL**
**€ 13,00**
**TUERCAS REMACHABLES DE ALUMINIO**

 M4: 50 Pz - M5: 35 Pz - M6: 15 Pz -  
 M8: 10 Pz - M10: 10 Pz.

Tuercas remachables M4 - M5 - M6 - M8 - M10

**0376/AI**
**€ 36,40**
**TUERCAS REMACHABLES DE ACERO INOX**

 M3: 40 Pz - M4: 40 Pz - M5: 30 Pz  
 - M6: 20 Pz - M8: 10 Pz - M10: 5 Pz  
 - M12: 5 Pz.



Tuercas remachables M3 - M4 - M5 - M6 - M8 - M10 - M12

**0178**
**€ 11,00**
**SURTIDO DE ARANDELAS**

 50 Pz Grower #6; 50 Pz Grower #8; 50  
 Pz Grower #10; 40 Pz Grower 1/4"; 30 Pz  
 Grower 5/16"; 20 Pz Grower 3/8"; 50 Pz  
 Dent. ext. #6; 50 Pz Dent. ext. #8; 50 Pz  
 Dent. ext. #10; 40 Pz Dent. ext. 1/4"; 30  
 Pz Dent. ext. 5/16"; 20 Pz Dent. ext. 3/18";  
 50 Pz Dent. int. #6; 50 Pz Dent. int. #8; 50  
 Pz Dent. int. #10; 40 Pz Dent. int. 1/4"; 30  
 Pz Dent. int. 5/16"; 20 Pz Dent. int. 3/18".

720 Pcs Caja Aluminio

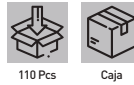
**0229**
**€ 16,40**
**SURTIDO DE ARANDELAS DE COBRE**

 30 Pz M6; 25 Pz M8; 20 Pz M10;  
 15 Pz M12; 10 Pz M14; 10 Pz M16.

110 Pcs Caja

**0294**
**€ 11,70**
**SURTIDO DE ESPIGAS**

 150 Pcs 1/16" x 1";  
 150 Pcs 3/32" x 1";  
 100 Pcs 3/32" x 1 - 1/2";  
 80 Pcs 1/8" x 1-1/4";  
 50 Pcs 1/8" x 2";  
 30 Pcs 5/32" x 2-1/2".

555 Pcs Caja Acero

**0298**
**€ 10,70**
**SURTIDO DE ESPIGAS DE SEGURO**

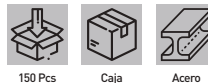
 42 Pz 3/32"x1-3/16"; 30 Pz 5/64"x1-  
 5/16"; 25 Pz 5/64"x1-9/16"; 25 Pz  
 7/64"x1-5/18"; 20 Pz 9/64"x1-3/4"; 8  
 Pz 5/32"x2-15/16".

150 Pcs Caja Acero

**0231**
**€ 11,80**
**SURTIDO DE CHAVETAS ELASTICAS**

 4 Pz 4x16 mm; 4 Pz 4x26 mm; 4 Pz 4x40  
 mm; 4 Pz 6x16 mm; 4 Pz 6x32 mm; 4 Pz  
 6x45 mm; 4 Pz 8x20 mm; 4 Pz 8x40 mm; 4  
 Pz 8x50 mm; 4 Pz 2x6 mm; 4 Pz 2x14 mm;  
 4 Pz 2x26 mm; 4 Pz 1.5x5 mm; 4 Pz 1.5x20  
 mm; 4 Pz 1.5x8 mm; 4 Pz 2.5x16 mm; 4 Pz  
 2.5x24 mm; 4 Pz 2.5x32 mm; 5 Pz 3x16  
 mm; 5 Pz 3x26 mm; 5 Pz 3x32 mm; 2 Pz  
 10x20 mm; 2 Pz 10x40 mm; 2 Pz 10x50  
 mm; 4 Pz 5.5x32 mm; 4 Pz 5.5x45 mm; 4 Pz  
 5.5x16 mm; 5 Pz 5x16 mm; 5 Pz 5x26 mm; 5  
 Pz 5x32 mm.

120 Pcs Caja Acero

**0296**
**€ 11,70**
**SURTIDO DE ANILLOS ELASTICOS**

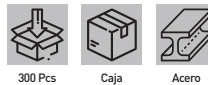
 30 Pz 1/16"; 30 Pz 1/8"; 40 Pz 3/16";  
 50 Pz 1/4"; 50 Pz 3/8"; 40 Pz 1/2"; 20  
 Pz 5/8"; 20 Pz 3/4"; 20 Pz 7/8";

300 Pcs Caja Acero

**0179** € 10,70

**SURTIDO DE ANILLOS ELASTICOS**

3 Pz ø 32; 5 Pz ø 25; 5 Pz ø 22; 10 Pz ø 16; 10 Pz ø 14; 10 Pz ø 10; 5 Pz R14; 10 Pz R12; 10 Pz R10; 10 Pz ø 9; 10 Pz ø 8; 12 Pz ø 6.



100 Pcs Colgante Caja Acero

**0263** € 14,10

**SURTIDO DE CHAVETAS DE DISCO**

10 Pz 4x7.5x19 mm; 10 Pz 5x7.5x19 mm; 10 Pz 3x5x13 mm; 10 Pz 3x6.5x16 mm; 10 Pz 4x5x13 mm; 10 Pz 4x6.5x16 mm; 10 Pz 5x9x22 mm; 10 Pz 6x9x22 mm. Tolerancia ±1 mm.



80 Pcs Caja Acero

**0257** € 14,10

**SURTIDO DE CHAVETAS**

5 Pz 6x6x20 mm; 4 Pz 3x3x20 mm; 4 Pz 3x3x25 mm; 5 Pz 8x5x32 mm; 5 Pz 5x5x20 mm; 5 Pz 8x7x36 mm; 5 Pz 5x5x25 mm; 5 Pz 10x8x40 mm; 5 Pz 5x5x36 mm; 5 Pz 10x8x50 mm; 5 Pz 6x6x36 mm; 2 Pz 12x8x40 mm; 5 Pz 6x6x50 mm.



60 Pcs Caja Acero

**0116** € 11,70

**SURTIDO DE BOLAS DE ACERO CROMADAS METRICAS**

DIN 5401, clase III 50 Pz 2.00mm; 50 Pz 2.50mm; 50 Pz 3.00mm; 50 Pz 3.50mm; 50 Pz 4.00mm; 50 Pz 4.50mm; 50 Pz 5.00mm; 30 Pz 5.50mm; 30 Pz 6.00mm; 20 Pz 7.00mm; 20 Pz 8.00mm.



450 Pcs Caja Acero 5401

**0116P** € 14,50

**SURTIDO DE BOLAS DE ACERO CROMADAS EN PULGADAS**

DIN 5401, clase III 50 Pz 3/32"; 50 Pz 1/8"; 50 Pz 5/32"; 50 Pz 3/16"; 50 Pz 7/32"; 50 Pz 1/4"; 30 Pz 9/32"; 30 Pz 5/16"; 30 Pz 11/32"; 20 Pz 3/8"; 20 Pz 13/32".



430 Pcs Caja Acero 5401

**0180** € 11,70

**SURTIDO DE RESORTES**

10Pz Comp.9/32"x 1/2"; 10Pz Ext.13/64"x 13/16"; 10Pz Comp.3/8"x 5/8"; 10Pz Ext.5/16"x 1-1/8"; 10Pz Comp.1/4"x 13/32"; 1Pz Ext.7/32"x 1"; 10 Pz Comp.3/8"x 3/4"; 10Pz Comp.7/32"x 11/16"; 10Pz Ext.1/4"x 7/8"; 10Pz Ext.5/16"x 1-1/4"; 10Pz Ext.11/32"x 1-27/32"; 10Pz Ext.5/16"x 1-3/4"; 10Pz Ext.9/32"x 2"; 10Pz Ext.5/32"x 3-1/8"; 10Pz Comp.23/64"x 1-3/8"; 10Pz Ext.3/16"x 1-3/4"; 10Pz Comp.7/32"x 1-1/2"; 10Pz Ext.9/32"x 1-1/2"; 10Pz Comp.9/32"x 3/4"; 10Pz Ext.11/32"x 1-7/16".

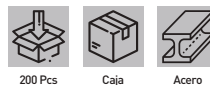

200 Pcs Caja Acero

**0299** € 22,20

**SURTIDO DE JUNTAS TORICAS MÉTRICO**

419 piezas en 32 tamaños diferentes fabricadas en caucho nitrilo NBR de alta calidad, resistente al calor, resistente al aceite, resistente al gas.

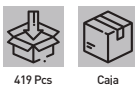

419 Pcs Caja

**0299/P** € 22,20

**SURTIDO DE JUNTAS TORICAS EN PULGADAS**

Surtido fabricado en caucho nitrilo NBR de alta calidad, resistente al calor, resistente al aceite, resistente al gas.

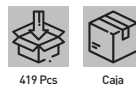

419 Pcs Caja

**0177**
**€ 11,30**
**SURTIDO DE OR**

10 Pz 3/32" x 15/64"; 20 Pz 1/8" x 1/4"; 20 Pz 5/32" x 9/32"; 20 Pz 3/16" x 5/16"; 15 Pz 7/32" x 11/32"; 15 Pz 1/4" x 3/8"; 10 Pz 9/16" x 3/4"; 10 Pz 5/8" x 13/16"; 10 Pz 11/16" x 7/8"; 10 Pz 3/4" x 15/16"; 10 Pz 3/4" x 1"; 10 Pz 13/16" x 11/16"; 15 Pz 5/16" x 7/16"; 10 Pz 3/8" x 1/2"; 10 Pz 5/8" x 3/4"; 10 Pz 3/8" x 9/16"; 10 Pz 7/16" x 5/8"; 10 Pz 1/2" x 11/16".



225 Pcs Colgante Caja

**0261**
**€ 9,80**
**JUEGO DE GRAPAS**

2 Pz 12.8x0.9x50-70 mm;  
4 Pz 12.8x0.9x35-50 mm;  
2 Pz 12.8x0.9x25-40 mm; 6 Pz 10x0.8x12-22 mm.

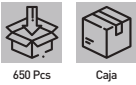

Dimensiones 10 x 0,8 x 12-22 mm ; 12,8 x 0,9 x 25-40 mm ; 12,8 x 0,9 x 35-50 mm ; 12,8 x 0,9 x 50-70 mm

**0876**
**€ 12,80**
**JUEGO DE CABLES**

300 Pz 2,5 x 100 mm  
200 Pz 3,6 x 150 mm  
150 Pz 4,8 x 200 mm

**0398**
**€ 10,00**
**SURTIDO DE TORNILLOS Y TUERCAS TIPO U**

Tornillos: 3x8mm 40Pz 4x16mm  
20Pz 5x12mm 15Pz 6x20mm 10Pz  
Tuercas tipo U: 3mm 20Pz 4mm con  
tacca 20Pz 4mm 20Pz 5mm 15Pz  
6mm 10Pz.



170 Pcs Caja Acero

**0465**
**€ 9,30**
**SURTIDO DE PASACABLES DE GOMA**

Medidas pasacables: 5 Pz - D 21 mm - ID 15 mm - OD 26 mm - T 2,2 mm 40 Pz - D 9 mm - ID 6 mm - OD 13 mm - T 2,1 mm 5 Pz - D 15 mm - ID 12 mm - OD 19 mm - T 1,9 mm 40 Pz - D 5,8 mm - ID 2,5 mm - OD 7,9 mm - T 1,8 mm 40 Pz - D 7,5 mm - ID 4,8 mm - OD 9,8 mm - T 1,8 mm 20 Pz - D 12 mm - ID 10,5 mm - OD 15 mm - T 1,8 mm 25 Pz - D 11 mm - ID 8,5 mm - OD 14,5 mm - T 1,5 mm 5 Pz - D 25 mm - ID 18 mm - OD 32 mm - T 1,5 mm.

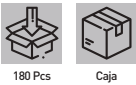

180 Pcs Caja

**0468**
**€ 10,40**
**SURTIDO DE ESCUADRAS Y RECTANGULARES CON TORNILLOS**

4 Pz escuadras: 25x25x16x2,0mm  
8 Pz escuadras: 40x40x16x2,0mm  
4 Pz escuadras: 60x60x16x2,0mm  
4 Pz escuadras: 75x75x16x2,0mm  
4 Pz escuadras a L:  
40x40x12x2,0mm 4 Pz escuadras a L: 60x60x12x2,0mm 4 Pz rectangulares: 80x15x2,0mm 4 Pz rectangulares: 40x15x2,0mm 144 Pz tornillos: 3x16mm.



180 Pcs Caja Acero

**0307/1**
**€ 20,80**
**SURTIDO DE FUSIBLES EN VIDRIO**

Rapido: 10 x 1A F1, 10 x 1.25A F1, 10 x 1.6A F1, 10 x 2A F1, 10 x 2.5A F1, 10 x 4A F1, 10 x 5A F1, 10 x 6.3A F1, 10 x 10A F1, retardados: 10 x 1A F1 T, 10 x 1.25A F1 T, 10 x 1.6A F1 T, 10 x 2A F1 T, 10 x 2.5A F1 T, 10 x 4A F1 T, 10 x 5A F1 T, 10 x 6.3A F1 T, 10 x 10A F1 T.

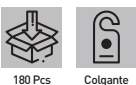

Dimensiones 5 x 20 mm

**0307/2**
**€ 23,40**
**SURTIDO DE FUSIBLES EN VIDRIO**

Retardados: 10 Pz 100mA T, 10 Pz 160mA T, 10 Pz 200mA T, 10 Pz 250mA T, 10 Pz 315mA T, 10 Pz 400mA T, 10 Pz 500mA T, 10 Pz 630mA T, 10 Pz 800mA T, rápido: 10 Pz 100mA F, 10 Pz 160mA F, 10 Pz 200mA F, 10 Pz 250mA F, 10 Pz 315mA F, 10 Pz 400mA F, 10 Pz 500mA F, 10 Pz 630mA F, 10 Pz 800mA F.



Dimensiones 5 x 20 mm



**0317** € 12,50

**SURTIDO FUSIBLES COCHE**

3A 15 Pz, 5A 15 Pz, 7.5A 15 Pz, 10A 15 Pz, 15A 15 Pz, 20A 15 Pz, 25A 15 Pz, 30A 15 Pz, Fuse puller 1 Pz.

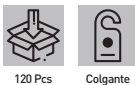

120 Pcs Colgante

Dimensiones 19,1 x 5,1 x 18,5 mm

**0318** € 13,40

**SURTIDO FUSIBLES COCHE**

2 AMP x 10 pz; 3 AMP x 10 pz; 4 AMP x 10 pz; 5 AMP x 10 pz; 7.5 AMP x 20 pz; 10 AMP x 10 pz; 15 AMP x 20 pz; 20 AMP x 20 pz; 25 AMP x 20 pz; 30 AMP x 10 pz; Fuse Puller x 1.

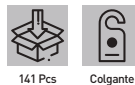

141 Pcs Colgante

Dimensiones 10,9 x 3,6 x 16,3 mm

**0293** € 15,20

**SURTIDO DE TERMINALES**

15 Pz FDD1-110 2.8x0.5/0.8 mm; 15 Pz FDD1-187 4.75x0.5/0.8 mm; 10 Pz FDD2-187 6.35x0.5/0.8 mm; 15 Pz FDD1-250 4.75x0.5/0.8 mm; 10 Pz FDD2-250 6.35x0.8 mm; 10 Pz FDD5-250 6.35x0.8 mm; 10 Pz BV1; 10 Pz BV2; 10 Pz BV5; 10 Pz MDD1-250; 10 Pz MDD2-250; 10 Pz MDD5-250; 10 Pz SVL1.25-3.7; 10 Pz SVL1.25-4; 10 Pz SVL1.25-5.3; 10 Pz SVM2-4; 10 Pz SVS2-5; 10 Pz SVL5-4; 10 Pz SVL5.5-4.

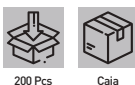

200 Pcs Caja

**0877** € 11,90

**JUEGO DE TERMINALES**

50 Pz 0.5mm<sup>2</sup>; 100 Pz 0.75mm<sup>2</sup>; 100 Pz 1.0 mm<sup>2</sup>; 100 Pz 1.5 mm<sup>2</sup>; 50 Pz 2.5 mm<sup>2</sup>.

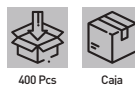

400 Pcs Caja

Terminal Blanco	100 x 0,5 mm <sup>2</sup>
Terminal Gris	100 x 0,75 mm <sup>2</sup>
Terminal Rojo	50 x 1 mm <sup>2</sup>
Terminal Negro	100 x 1,5 mm <sup>2</sup>
Terminal Azul	50 x 2,5 mm <sup>2</sup>

**0380** € 10,70

**SURTIDO TUBO TERMORETRÁCTIL**

30 Pz 5/64"x1-9/16"; 25 Pz 3/32"x1-9/16"; 20 Pz 1/8"x1-9/16"; 30 Pz 3/16"x1-9/16"; 16 Pz 9/32"x3-1/8"; 8 Pz 3/8"x3-1/8"; 8 Pz 1/2"x3-3/8".

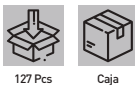

127 Pcs Caja

**0176** € 33,40

**SURTIDO DE ENGRASADORES**

Pz. 35 rectas M6x1; Pz. 15 rectas 1/8"-27; Pz. 5 45° 1/8"-27; Pz. 5 45° M6x1; Pz. 10 45° M8x1; Pz. 5 45° M10x1; Pz. 10 rectas M10x1; Pz. 10 rectas M8x1; Pz. 5 90° M6x1; Pz. 5 90° M8x1; Pz. 5 90° M10x1.

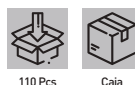

110 Pcs Caja

**SR44W** € 5,80

**BATERIAS PARA INSTRUMENTOS DIGITALES**



Colgante

Voltaje	1,5 V
Pack	10



**CR20X**

**BATERIAS PARA INSTRUMENTOS DIGITALES**

Art.	€	Voltaje	Pack
CR2025	€ 8,00	3 V	10
CR2032	€ 8,00	3 V	10



**0678**

€ 21,10

**PISTOLA PARA ESPUMA POLIURETANO**

Regulador del flujo de resina y de la tuerca para el montaje del aerosol de resina.



Caja

Longitud

290 mm

**0085**

€ 12,90

**PISTOLA DE SILICONA**



Niquelada



**0521**

€ 10,40

**PISTOLA DE SILICONA**



Niquelada



**0234**

€ 4,52

**PISTOLA DE SILICONA REFORZADA CON ASTA HEXAGONAL**



Acero



**0091**

€ 3,94

**PISTOLA DE SILICONA A CREMALLERA**



**0861**

€ 21,10

**PISTOLA PARA SELLOS QUIMICOS DE 380ML**



Niquelada



**0819-**  
**PALETA REDONDA**



Art.	€	Longitud
0819/18	€ 5,10	180 mm
0819/20	€ 5,30	200 mm

**0820-**  
**PALETA CUADRADA**



Art.	€	Longitud
0820/18	€ 5,10	180 mm
0820/20	€ 5,30	200 mm

**0822** **€ 5,70**  
**LLANA CON MANGO DE ABS**



Longitud	280 x 120 mm
----------	--------------

**0823** **€ 5,70**  
**LLANA RANURADA CON MANGO DE ABS**



Longitud	280 x 120 mm
----------	--------------

**0184-**  
**ESPATULA DE PINTOR CON MANGO DE PLASTICO**

**INOX**



Art.	€	Dimensiones hoja
0184/01	€ 1,56	30 x 90h mm
0184/02	€ 1,56	50 x 85h mm
0184/03	€ 2,03	75 x 100h mm
0184/04	€ 3,11	100 x 100h mm

**0606** **€ 4,82**  
**CUBO DE ALBANIL EN POLIETILENO**



Dimensiones	Ø 360 x 240h mm
Capacidad	14 l



**0043 € 6,00**
**CINTA DE OBRAS DE PLASTICO ROJA Y BLANCA**

Longitud	200 m
Altura	70 mm

**0103 € 9,10**
**DISPENSADOR DE CINTAS PARA EL EMBALAJE**

Caja

**0747 € 2,65**
**CINTA DE PPL COLOR HABANA PARA EL EMBALAJE**

Dimensiones correa	50 mm x 66 m
Pack	6

**0760 € 9,10**
**MANIJA PARA PELICULA EXTENSIBLE**

**PVC300/125 € 5,50**
**PELÍCULA EXTENSIBLE PARA EMBALAJE**

Dimensiones	0,125h x 100 m
Espesor	20 µm
Pack	48

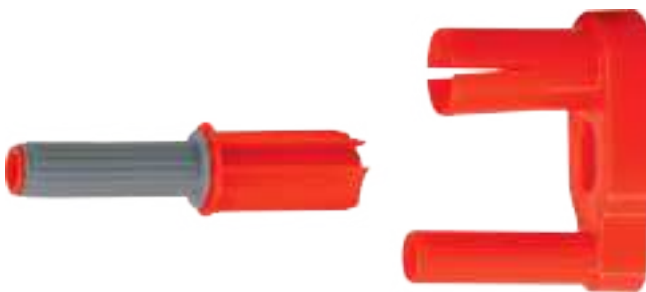
**0748 € 10,80**
**MANIJAS PARA PELICULA EXTENSIBLE**

**PVC300 € 20,60**
**PELICULA EXTENSIBLE PARA EMBALAJE**

Dimensiones	0,5h x 300 m
Espesor	23 µm
Pack	6

**028X**
**TELON DE PROTECCION DE POLIETILENO/BICOLOR GRIS/AZUL**

Resistente a los rayos uva, telon tejido en polietileno de 140/150 g/m2 de resistencia con cuerda metalica cada 50cm.



Art.	€	Dimensiones	Peso neto
0281	€ 12,40	2,86 x 1,90 m	0,9 kg
0282	€ 35,80	4 x 5 m	2,8 kg
0283	€ 71,50	5 x 8 m	5,6 kg
0284	€ 93,20	6 x 10 m	8 kg



**C960/AM01**

€ 1190,00

**CARRO CON HERRAMIENTAS PARA AUTOMOCIÒN**



142 Pcs

Bandejas incluidas	TM01/047, TM01/048, TM01/049
Dimensiones	770 x 460 x 985h mm
Dimensiones cajón	566 x 405 mm
Altura del cajón	6 x 68 mm - 1 x 199 mm
Capacidad cajón	6 x 25 kg - 1 x 40 kg

**C960/CC01**

€ 1190,00

**CARRO CON HERRAMIENTAS**



159 Pcs

Bandejas incluidas	TM01/002, TM01/010, TM01/012, TM01/014, TM01/016, TM01/018, TM01/023, TM01/025, TM01/030, TM01/033, TM01/042
Dimensiones	770 x 460 x 985h mm
Dimensiones cajón	566 x 405 mm
Altura del cajón	6 x 68 mm - 1 x 199 mm
Capacidad cajón	6 x 25 kg - 1 x 40 kg

**C960/CC03**
**€ 1080,00**
**CARRO CON HERRAMIENTAS**

253 Pcs

Bandejas incluidas	TM01/068, TM01/069, TM01/070
Dimensiones	770 x 460 x 985h mm
Dimensiones cajón	566 x 405 mm
Altura del cajón	6 x 68 mm - 1 x 199 mm
Capacidad cajón	6 x 25 kg - 1 x 40 kg

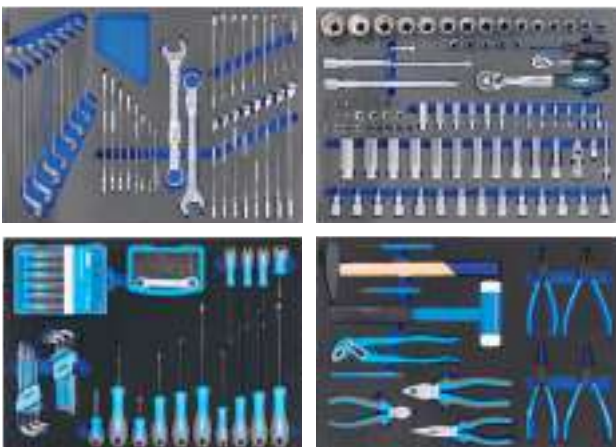
**C960/CC04**
**€ 1340,00**
**CARRO CON HERRAMIENTAS**

219 Pcs

Bandejas incluidas	TM01/058, TM01/063, TM01/064, TM01/061
Dimensiones	770 x 460 x 985h mm
Dimensiones cajón	566 x 405 mm
Altura del cajón	6 x 68 mm - 1 x 199 mm
Capacidad cajón	6 x 25 kg - 1 x 40 kg



**C960CA**

€ 999,00

**CARRO CON HERRAMIENTAS**

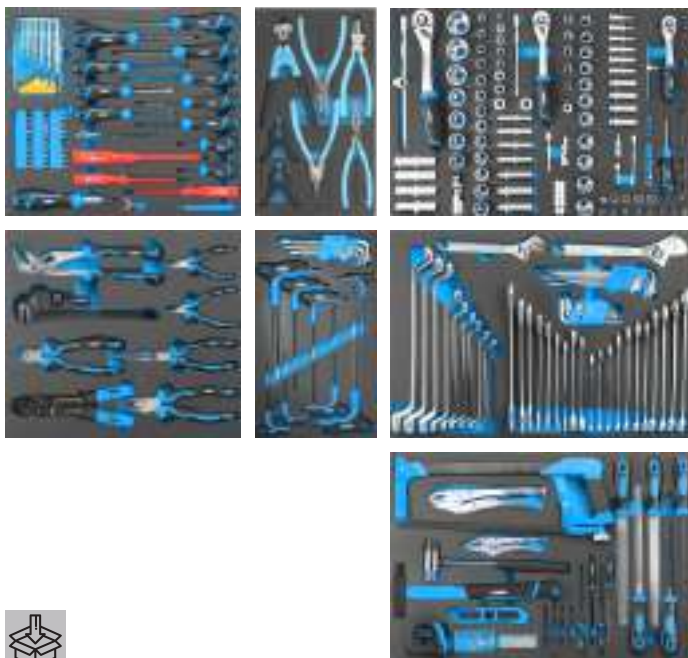

290 Pcs

Bandejas incluidas	C960/1A, C960/2A, C960/3A, C960/4A, C960/5A, C960/7A, C960/8A
Dimensiones	770 x 460 x 985h mm
Dimensiones cajón	566 x 405 mm
Altura del cajón	6 x 68 mm - 1 x 199 mm
Capacidad cajón	6 x 25 kg - 1 x 40 kg

**C960C3C**

€ 799,00

**CARRO CON HERRAMIENTAS**



235 Pcs

Bandejas incluidas	C960/1A, C960/3A, C960/4A
Dimensiones	770 x 460 x 985h mm
Dimensiones cajón	566 x 405 mm
Altura del cajón	6 x 68 mm - 1 x 199 mm
Capacidad cajón	6 x 25 kg - 1 x 40 kg

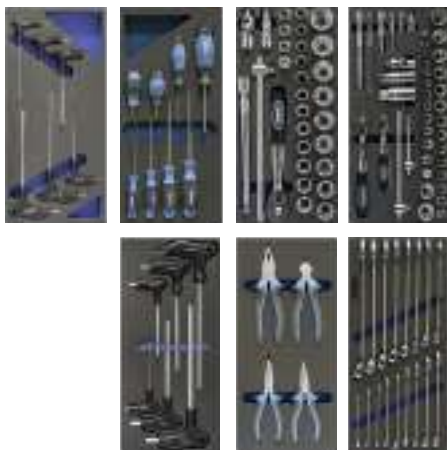
**C900/CC01**
**€ 720,00**
**CARRO CON HERRAMIENTAS**

113 Pcs

Bandejas incluidas	TM01/001, TM01/012, TM01/014, TM01/020, TM01/022, TM01/024, TM01/042
Dimensiones cajonera	744 x 461 x 964h mm
Dimensiones cajón	569 x 406 mm
Altura del cajón	4 x 45 mm - 1 x 145 mm - 1 x 225 mm
Capacidad cajón	25 kg

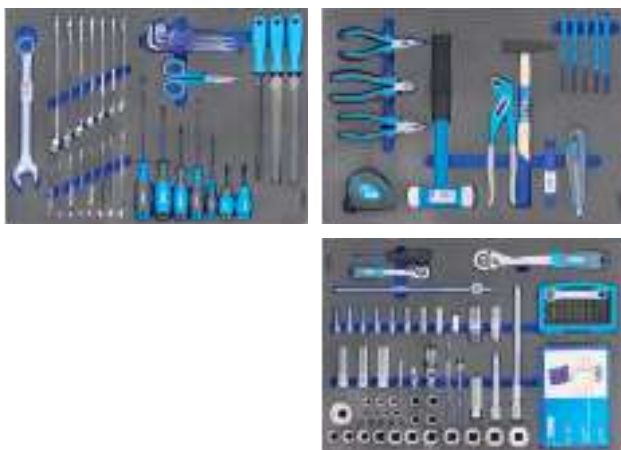
**C900/CC03**
**€ 882,00**
**CARRO CON HERRAMIENTAS**

253 Pcs

Bandejas incluidas	TM01/068, TM01/069, TM01/070
Dimensiones	744 x 461 x 964h mm
Dimensiones cajón	569 x 406 mm
Altura del cajón	4 x 45 mm - 1 x 145 mm - 1 x 225 mm
Capacidad cajón	25 kg



**C900/CC04**

€ 1160,00

**CARRO CON HERRAMIENTAS**



219 Pcs

Bandejas incluidas	TM01/058, TM01/063, TM01/064, TM01/061
Dimensiones	744 x 461 x 964h mm
Dimensiones cajón	569 x 406 mm
Altura del cajón	4 x 45 mm - 1 x 145 mm - 1 x 225 mm
Capacidad cajón	25 kg

**C900CA**

€ 854,00

**CARRO CON HERRAMIENTAS**

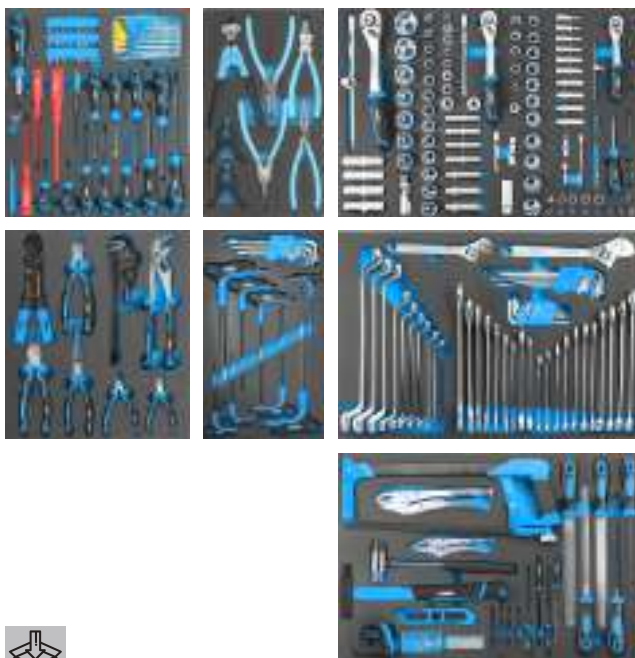

290 Pcs

Bandejas incluidas	C960/1A, C960/2A, C960/3A, C960/4A, C960/5A, C960/7A, C960/8A
Dimensiones	744 x 461 x 964h mm
Dimensiones cajón	569 x 406 mm
Altura del cajón	4 x 70 mm - 1 x 145 mm - 1 x 225 mm
Capacidad cajón	25 kg

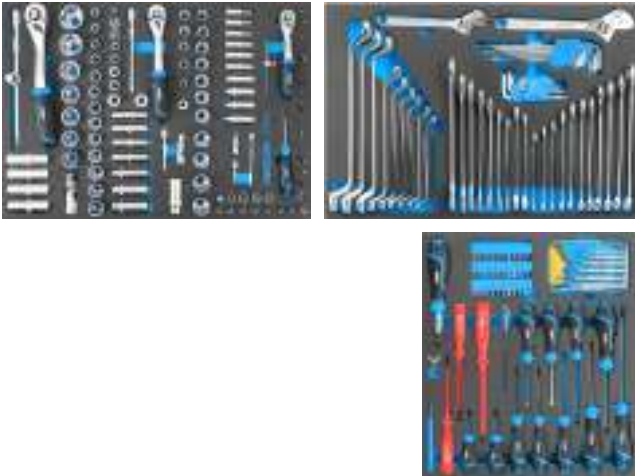
**C900C3C**
**€ 663,00**
**CARRO CON HERRAMIENTAS**

235 Pcs

Bandejas incluidas	C960/1A, C960/3A, C960/4A
Dimensiones	744 x 461 x 964h mm
Dimensiones cajón	569 x 406 mm
Altura del cajón	4 x 70 mm - 1 x 145 mm - 1 x 225 mm
Capacidad cajón	25 kg





**¡ESCANEA EL  
CÓDIGO QR DEDICADO  
Y DESCUBRE EL  
CONTENIDO  
DETALLADO!**

**C960/1A**

**€ 163,00**

**HERRAMIENTAS EN BANDEJA BLANDA PARA CAJONES**

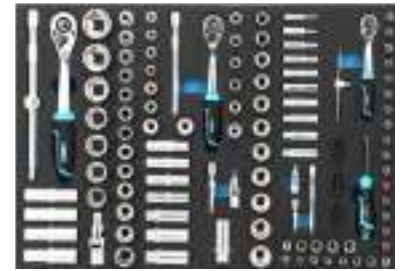

Dimensiones

570 x 390 x 35 mm

**C960/2A**

**€ 72,00**

**HERRAMIENTAS EN BANDEJA BLANDA PARA CAJONES**

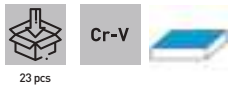

Dimensiones

570 x 390 x 35 mm

**C960/3A**

**€ 202,00**

**HERRAMIENTAS EN BANDEJA BLANDA PARA CAJONES**



Dimensiones

570 x 390 x 35 mm

**C960/4A**

**€ 47,00**

**HERRAMIENTAS EN BANDEJA BLANDA PARA CAJONES**



Dimensiones

405 x 390 x 35 mm

**C960/5A**

**€ 57,00**

**HERRAMIENTAS EN BANDEJA BLANDA PARA CAJONES**

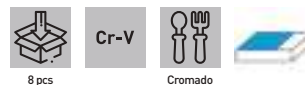

Dimensiones

405 x 390 x 35 mm

**C960/7A**

**€ 28,00**

**HERRAMIENTAS EN BANDEJA BLANDA PARA CAJONES**

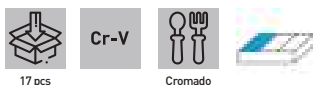

Dimensiones

405 x 240 x 35 mm

**C960/8A**

**€ 39,00**

**HERRAMIENTAS EN BANDEJA BLANDA PARA CAJONES**



Dimensiones

405 x 240 x 35 mm

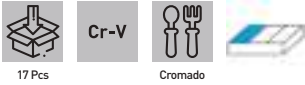
**TM01/001 € 60,80**
**JUEGO DE LLAVES COMBENADAS EN BANDEJA**

Dimensiones 188 x 405 x 33 mm

**TM01/002 € 125,00**
**JUEGO DE LLAVES COMBENADAS EN BANDEJA**

Dimensiones 188 x 405 x 33 mm

**TM01/005 € 63,80**
**JUEGO DE LLAVES DE DOS BOCAS EN BANDEJA**

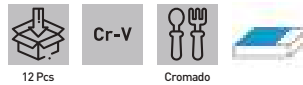

Dimensiones 376 x 405 x 33 mm

**TM01/006 € 96,70**
**JUEGO DE LLAVES DE DOS BOCAS EN BANDEJA**

Dimensiones 376 x 405 x 33 mm

**TM01/056 € 203,00**
**JUEGO DE LLAVES DE TRINQUETE VARIADAS ARTICULADAS DE MATERIAL TERMOFORMADO BLANDO**

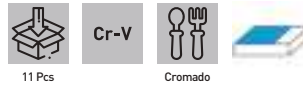
Dimensiones 188 x 405 x 33 mm

**TM01/008 € 168,00**
**JUEGO DE LLAVES DE 6 CARAS MACHO EN "T" EN BANDEJA**

Dimensiones 376 x 405 x 33 mm

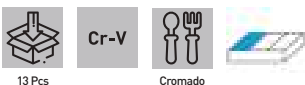
**TM01/009 € 173,00**
**JUEGO DE LLAVES TORX MACHO EN "T" EN BANDEJA**

Dimensiones 188 x 405 x 33 mm

**TM01/010 € 263,00**
**JUEGO DE LLAVES DE VASO HEXAGONAL ARTICULADA MAGNETICA EN T EN BANDEJA**

Dimensiones 565 x 405 x 33 mm



**TM01/011**

€ 290,00

**JUEGO DE LLAVES DE VASO HEXAGONAL ARTICULADA MAGNETICA EN T EN BANDEJA**



Dimensiones 565 x 405 x 33 mm

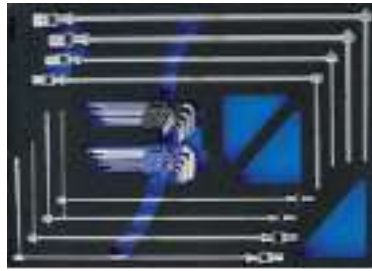

**TM01/012**

€ 48,40

**JUEGO DE LLAVES ACODADAS CON MANGO ANATOMICO DE PLASTICO EN BANDEJA**

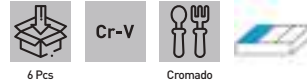

Dimensiones 188 x 405 x 33 mm



**TM01/014**

€ 48,40

**JUEGO DE LLAVES ACODADS TORX CON MANGO ANATOMICO DE PLASTICO EN BANDEJA**

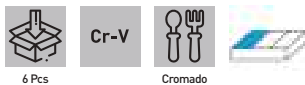

Dimensiones 188 x 405 x 33 mm



**TM01/063**

€ 177,00

**SERIE DE HERRAMIENTAS PARA AUTOMOTIVE EN BANDEJA**



Dimensiones 565 x 405 x 33 mm



**TM01/068**

€ 89,00

**SERIE DE HERRAMIENTAS PARA AUTOMOTIVE EN BANDEJA**

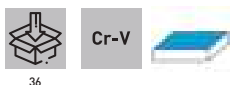

Dimensiones 565 x 405 x 33 mm



**TM01/016**

€ 42,20

**JUEGO DE DESTORNILLADORES BOCA PLANA EN BANDEJA**

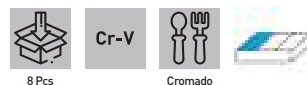

Dimensiones 188 x 405 x 33 mm



**TM01/018**

€ 48,40

**JUEGO DE DESTORNILLADORES EN CRUZ EN BANDEJA**



Dimensiones 188 x 405 x 33 mm



**TM01/020**

€ 43,30

**JUEGO DE DESTORNILLADORES EN BANDEJA**



Dimensiones 188 x 405 x 33 mm



**TM01/044** € 53,20

**JUEGO DE DESTORNILLADORES BOCA PLANA DE DIAMANTE EN BANDEJA**



Dimensiones 188 x 405 x 33 mm

**TM01/045** € 60,20

**JUEGO DE DESTORNILLADORES EN CRUZ DE DIAMANTE EN BANDEJA**



Dimensiones 188 x 405 x 33 mm

**TM01/046** € 53,90

**JUEGO DE DESTORNILLADORES CON BOCA DE DIAMANTE EN BANDEJA**



Dimensiones 188 x 405 x 33 mm

**TM01/070** € 223,00

**SERIE DE HERRAMIENTAS PARA AUTOMOTIVE EN BANDEJA**



Dimensiones 565 x 405 x 33 mm

**TM01/022** € 230,00

**JUEGO DE LLAVES DE VASO DE 6 CARAS EN BANDEJA**

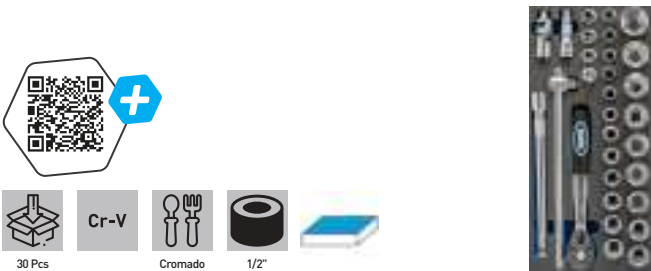

Dimensiones 188 x 405 x 33 mm

**TM01/023** € 225,00

**JUEGO DE LLAVES DE VASO DE 12 CARAS EN BANDEJA**

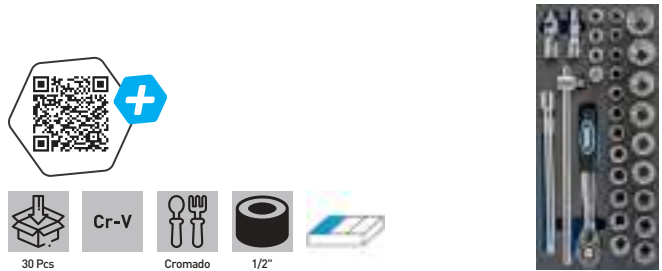

Dimensiones 188 x 405 x 33 mm

**TM01/024** € 233,00

**JUEGO DE LLAVES DE VASO DE 6 CARAS EN BANDEJA**



Dimensiones 188 x 405 x 33 mm

**TM01/025** € 229,00

**JUEGO DE LLAVES DE VASO DE 12 CARAS EN BANDEJA**



Dimensiones 188 x 405 x 33 mm



**TM01/026** € 46,30

**JUEGO DE DESTORNILLADORES AISLADOS EN BANDEJA**



Dimensiones 188 x 405 x 33 mm

**TM01/027** € 61,70

**JUEGO DE LLAVES DE VASO CON MANGO DE PLASTICO EN BANDEJA**



Dimensiones 188 x 405 x 33 mm

**TM01/028** € 74,10

**JUEGO DE LLAVES DE VASO CON MANGO DE PLASTICO EN BANDEJA**

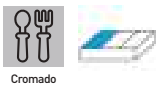
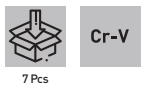

Dimensiones 188 x 405 x 33 mm

**TM01/029** € 71,00

**JUEGO DE LLAVES DE VASO FLEXIBLE CON MANGO DE PLASTICO EN BANDEJA**

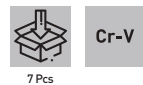

Dimensiones 188 x 405 x 33 mm

**TM01/030** € 45,40

**JUEGO DE LLAVES DE ESTRELLA ACODADAS DE DOS BOCAS EN BANDEJA**



Dimensiones 188 x 405 x 33 mm

**TM01/031** € 53,40

**JUEGO DE LLAVES DE ESTRELLA ACODADAS DE DOS BOCAS EN BANDEJA**

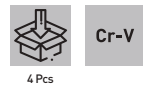

Dimensiones 188 x 405 x 33 mm

**TM01/032** € 53,40

**JUEGO DE LLAVES COMBINADAS EN BANDEJA**

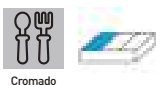

Dimensiones 188 x 405 x 33 mm

**TM01/033** € 75,10

**JUEGO DE LLAVES COMBINADAS EN BANDEJA**

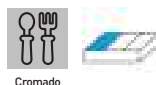

Dimensiones 188 x 405 x 33 mm

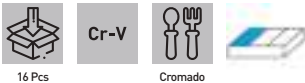
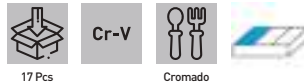
**TM01/035 € 143,00**
**JUEGO DE LLAVES DE TUBO EXAGONALES  
Y JUEGO DE LLAVES DE DOS BOCAS EN BANDEJA**

**Dimensiones 188 x 405 x 33 mm**
**TM01/036 € 81,30**
**JUEGO DE LLAVES DE TUBO EXAGONALES  
Y JUEGO DE LLAVES DE DOS BOCAS EN BANDEJA**

**Dimensiones 188 x 405 x 33 mm**
**TM01/069 € 139,00**
**SERIE DE HERRAMIENTAS PARA AUTOMOTIVE EN BANDEJA**

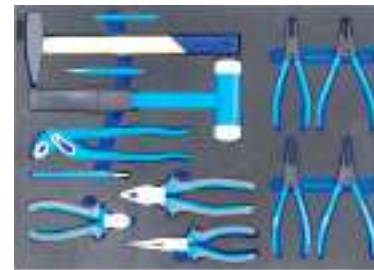
**Dimensiones 565 x 405 x 33 mm**
**TM01/037 € 84,30**
**JUEGO DE BOTADORES EN BANDEJA**

**Dimensiones 188 x 405 x 33 mm**
**TM01/038 € 96,70**
**JUEGO DE BOTADORES EN BANDEJA**

**Dimensiones 188 x 405 x 33 mm**
**TM01/064 € 153,00**
**SERIE DE HERRAMIENTAS PARA AUTOMOTIVE EN BANDEJA**

**Dimensiones 565 x 405 x 33 mm**
**TM01/042 € 45,40**
**JUEGO DE ALICATES EN BANDEJA**

**Dimensiones 188 x 405 x 33 mm**
**TM01/043 € 194,00**
**JUEGO DE LLAVES DE VASO DE IMPACTO DE 6 CARAS EN BANDEJA**

**Dimensiones 188 x 405 x 33 mm**



**TM01/047**

€ 190,00

**SERIE DE HERRAMIENTAS PARA AUTOMOTIVE EN BANDEJA**



43 pcs Cromado

Dimensiones

565 x 405 x 33 mm

**TM01/048**

€ 70,00

**SERIE DE HERRAMIENTAS PARA AUTOMOTIVE EN BANDEJA**

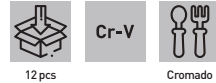
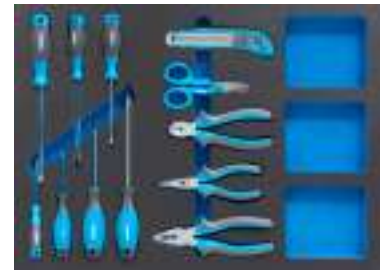

12 pcs Cromado

Dimensiones

565 x 405 x 33 mm

**TM01/049**

€ 285,00

**SERIE DE HERRAMIENTAS PARA AUTOMOTIVE EN BANDEJA**



83 pcs Cromado

Dimensiones

565 x 405 x 33 mm

**TM01/052**

€ 528,00

**SERIE NEUMÁTICA PARA AUTOMOTIVE EN BANDEJA**



19 Pcs Cromado

Dimensiones

565 x 405 x 33 mm

**TM01/054**

€ 20,60

**TERMOFORMADO PARA A007/16**



Dimensiones externas 155 x 405 x 33 mm  
Dimensiones internas 2: 103 x 166 x 25 mm

**TM01/055**

€ 20,60

**TERMOFORMADO PARA A007/16**



Dimensiones externas 155 x 405 x 33 mm  
Dimensiones internas 3: 103 x 104 x 25 mm

**TM01/100**

€ 20,60

**BANDEJA VACIA POR HERRAMIENTAS**



Dimensiones 188 x 405 x 33 mm

**TM01/110**

€ 30,90

**BANDEJA VACIA POR HERRAMIENTAS**



Dimensiones 376 x 405 x 33 mm

**TM01/120**

€ 41,20

**BANDEJA VACIA POR HERRAMIENTAS**



Dimensiones 564 x 405 x 33 mm

**0105T**
**€ 318,00**
**MALETA DE UTILES Y ACCESORIOS**

162 Pcs



Caja

**Cr-V**

Llaves hexagonales	1,5 - 2 - 2,5 - 3 - 4 - 5 - 6 - 8 - 10 mm
Destornilladores	(-) 5 x 75 - 6 x 100 mm - (+) 1 x 75 - 2 x 100 mm
Buscapolos	100 ÷ 250 V
Destornilladores de precisión	(-) 2 x 140 - 2,4 x 140 - 3 x 140 - (+) 00 x 140 mm - 0 x 140 mm
Pinzas	160 mm
Llave de rodillo	200 mm
Alicate de corte lateral	160 mm
Alicates con puntas semiredondas	160 mm
Tenaza ruza	220 mm
Tijeras multiuso	175 mm
Botadores y cinceles	5 Pcs
Alicates para arandelas con 4 cabezas	4 Pcs
Tenaza hidráulica	240 mm
Llaves combinadas	8-10-11-12-13-15-17-19-21 mm
Llaves de vaso de 1/4"	4-4,5-5-5,5-6-7-8-9-10-11-12-13-14 mm
Llaves de vaso de 1/2"	12-13-14-15-16-17-18-19-21-24-27-30-32 mm
Mango corredizo	1/4"
Articulacion universal	1/4" - 1/2"
Prolongaciones de 1/4"	50 mm - 100 mm
Prolongaciones de 1/2"	125 mm - 250 mm

Adaptador de 1/2" para mango corredizo	1 Pc
Medida de llaves de vaso para bujias	16 mm - 21 mm
Palancas con carraca	1/4" - 1/2"
Lima	200 mm
Martillo alemán	300 g
Flexómetro	5 m
Mini sierra de arco	1 Pc
Hoja	3 Pcs
Linterna de aluminio	1 Pc
Tenaza plegadora	200 mm
Terminal	35 Pcs
Cutter	1 Pc
Nivel	300 mm
Calibre de Vernier	150 mm
Porta insertos magnético	1 Pc
Insertos	30 - 1/4"
Porta insertos con carraca	1 Pc
Adaptador macho con cuadradillo de 1/4" y hex de 1/4"	1 Pc
Dimensiones maletín	470 x 350 x 135 mm
Peso neto	12 kg

**0110T**
**€ 269,00**
**MALETA DE UTILES Y ACCESORIOS**

135 Pcs



Caja

**Cr-V**

Llaves hexagonales	1,5 - 2 - 2,5 - 3 - 4 - 5 - 6 - 8 mm
Destornilladores	(-) 3 x 75 - 5 x 75 - 6 x 100 - 8 x 150 mm - (+) 0 x 75 - 1 x 75
Destornilladores de precisión	(-) 2,4 x 140 - (+) 00 x 140 mm - 0 x 140 mm
Pinzas	180 mm
Alicate con articulacion	150 mm
Alicate de corte lateral	115 mm
Alicates con puntas semiredondas	150 mm
Alicate pelacables	160 mm
Tijeras	200 mm
Tenaza hidráulica	240 mm
Llaves combinadas	6-8-10-13-14-15-17-19 mm
Llaves de vaso de 1/4"	4-5-6-7-8-9-10-11-12-13-14 mm
Llaves de vaso de 1/2"	8-9-10-11-12-13-14-15-16-17-18-19-20-21-22 mm
Mango corredizo	1/4"
Articulacion universal	1/4" - 1/2"
Prolongaciones de 1/4"	100 mm
Prolongaciones de 1/2"	250 mm
Adaptador de 1/2" para mango corredizo	1 Pc

Medida de llaves de vaso para bujias	16 mm - 21 mm
Palancas con carraca	1/4" - 1/2"
Alargadera flexible	1/4" - 145 mm
Llave de vaso porta insertos	1/4"
Martillo alemán	300 g
Flexómetro	5 m
Mini sierra de arco	1 Pc
Terminal	20 Pcs
Cutter	1 Pc
Hoja	5 Pcs
Nivel	300 mm
Mango per llaves de vaso	1/4"
Porta insertos magnético	1/4"
Insertos	30 - 1/4"
Adaptador macho con cuadradillo de 1/4" y hex de 1/4"	1 Pc
Dimensiones maletín	470 x 350 x 135 mm
Peso neto	10 kg



0105

€ 272,00

**MALETA CON HERRAMIENTAS Y ACCESORIOS**



Cr-V

162 Pcs

Caja

Llaves hexagonales	1,5 - 2 - 2,5 - 3 - 4 - 5 - 6 - 8 - 10 mm
Destornilladores	(-) 5 x 75 - 6 x 100 mm - (+) 1 x 75 - 2 x 100 mm
Buscapolos	100 ÷ 250 V
Destornilladores de precisión	(-) 2 x 140 - 2,4 x 140 - 3 x 140 - (+) 00 x 140 mm - 0 x 140 mm
Pinzas	160 mm
Llave de rodillo	200 mm
Alicate de corte lateral	160 mm
Alicates con puntas semiredondas	160 mm
Tenaza ruza	220 mm
Tijeras multiuso	175 mm
Botadores y cinceles	5 Pcs
Alicates para arandelas con 4 cabezas	4 Pcs
Tenaza hidráulica	240 mm
Llaves combinadas	8-10-11-12-13-15-17-19-21 mm
Llaves de vaso de 1/4"	4-4,5-5-5,5-6-7-8-9-10-11-12-13-14 mm
Llaves de vaso de 1/2"	12-13-14-15-16-17-18-19-21-24-27-30-32 mm
Mango corredizo	1/4"
Articulacion universal	1/4" - 1/2"
Prolongaciones de 1/4"	50 mm - 100 mm
Prolongaciones de 1/2"	125 mm - 250 mm

Adaptador de 1/2" para mango corredizo	1 Pc
Medida de llaves de vaso para bujias	16 mm - 21 mm
Palancas con carraca	1/4" - 1/2"
Lima	200 mm
Martillo alemán	300 g
Flexómetro	5 m
Mini sierra de arco	1 Pc
Hoja	3 Pcs
Linterna de aluminio	1 Pc
Tenaza plegadora	200 mm
Terminal	35 Pcs
Cutter	1 Pc
Nivel	300 mm
Calibre de Vernier	150 mm
Porta insertos magnético	1 Pc
Insertos	30 - 1/4"
Porta insertos con carraca	1 Pc
Adaptador macho con cuadradillo de 1/4" y hex de 1/4"	1 Pc
Dimensiones maletín	470 x 350 x 135 mm
Peso neto	11,5 kg

0110

€ 222,00

**MALETAS RESISTENTES AL AGUA**



Cr-V

135 Pcs

Caja

Llaves hexagonales	1,5 - 2 - 2,5 - 3 - 4 - 5 - 6 - 8 mm
Destornilladores	(-) 3 x 75 - 5 x 75 - 6 x 100 - 8 x 150 mm - (+) 0 x 75 - 1 x 75 - 2 x 100 x 100 mm
Destornilladores de precisión	(-) 2,4 x 140 - (+) 00 x 140 mm - 0 x 140 mm
Pinzas	180 mm
Alicate con articulacion	150 mm
Alicate de corte lateral	115 mm
Alicates con puntas semiredondas	150 mm
Alicate pelacables	160 mm
Tijeras	200 mm
Tenaza hidráulica	240 mm
Llaves combinadas	6-8-10-13-14-15-17-19 mm
Llaves de vaso de 1/4"	4-5-6-7-8-9-10-11-12-13-14 mm
Llaves de vaso de 1/2"	8-9-10-11-12-13-14-15-16-17-18-19-20-21-22 mm
Mango corredizo	1/4"
Articulacion universal	1/4" - 1/2"
Prolongaciones de 1/4"	100 mm
Prolongaciones de 1/2"	250 mm
Adaptador de 1/2" para mango corredizo	1 Pc

Medida de llaves de vaso para bujias	16 mm - 21 mm
Palancas con carraca	1/4" - 1/2"
Alargadera flexible	1/4" - 145 mm
Llave de vaso porta insertos	1/4"
Martillo alemán	300 g
Flexómetro	5 m
Mini sierra de arco	1 Pc
Terminal	20
Cutter	1 Pc
Hoja	5 Pcs
Nivel	300 mm
Mango per llaves de vaso	1/4"
Porta insertos magnético	1/4"
Insertos	30 - 1/4"
Adaptador macho con cuadradillo de 1/4" y hex de 1/4"	1 Pc
Dimensiones maletín	470 x 350 x 135 mm
Peso neto	9,5 kg

**0171**

€ 139,00

**MALETA CON HERRAMIENTAS Y ACCESORIOS**

Llaves hexagonales	1,5 - 2 - 2,5 - 3 - 4 - 5 - 6 - 8 - 10 mm
Destornilladores	(-) 5x75 - 6x100 mm (+) 1x75 - 2x100 mm
Tenaza hidráulica	250 mm
Tijeras multiuso	170 mm
Alicates de puntas redondas	150 mm
Alicates universales	170 mm
Alicate de corte lateral	150 mm
Llaves de vaso de 1/4"	4-5-6-7-8-9-10-11-12-13-14 mm
Llaves de vaso de 1/2"	10-12-13-15-17-18-19-20-22-24-27-30-32 mm
Llaves Allen para bujías 1/2"	16-21 mm
Martello	300 g
Llaves combinadas a carraca	1/2" - 1/4"
Porta casquillos	1/4"
Insertos	31 - 1/4"
Adaptador	1/2" F > 3/8" M
Llaves combinadas	8-10-11-12-13-15-17-19 mm
Mango corredizo	1/4"
Juntas	1/2" - 1/4"
Prolongaciones de 1/2"	250 mm
Prolongaciones de 1/4"	100 mm
Adaptador macho con cuadradillo de 1/4" y hex de 1/4"	1 Pc
Dimensiones maletín	470 x 330 x 100h mm
Peso neto	16,0 kg

**0399**

€ 202,00

**MALETA DE UTILES Y ACCESORIOS**

Estuche duradero con asa ergonómica.



Llaves hexagonales	1,5 - 2 - 2,5 - 3 - 4 - 5 - 6 - 8 mm
Destornilladores	(-) 5 x 75 - 6 x 100 mm - (+) 1 x 75 - 2 x 100 mm
Pinzas	150 mm
Llave de rodillo	250 mm
Alicate de corte lateral	150 mm
Alicates con puntas semiredondas	150 mm
Tijeras multiuso	150 mm
Tenaza hidráulica	240 mm
Llaves combinadas	8-10-11-12-13-14-15-17 mm
Llaves de vaso de 1/4"	4-4,5-5-5,5-6-7-8-9-10-11-12-13-14 mm
Llaves de vaso de 1/2"	10-13-14-15-16-17-19-21-22 mm
Mango corredizo	1/4"
Articulacion universal	1/4" - 1/2"
Prolongaciones de 1/4"	50 mm - 100 mm
Prolongaciones de 1/2"	125 mm
Medida de llaves de vaso para bujías	16 mm - 21 mm
Palancas con carraca	1/4" - 1/2"
Martillo alemán	300 g
Cutter	1 Pc
Porta insertos magnético	1 Pc
Insertos	30 Pcs
Adaptador insertos	1/4"
Porta insertos con carraca	1 Pc
Adaptador macho con cuadradillo de 1/4" y hex de 1/4"	1 Pc
Dimensiones maletín	450 x 360 x 120 mm
Peso neto	7 kg





0434

€ 97,80

**MALETA DE UTILES Y ACCESORIOS**



Cr-V

53 Pcs

Caja

Llaves hexagonales	1,5 - 2 - 2,5 - 3 - 4 - 5 - 6 - 8 - 10 mm
Destornilladores	(-) 5 x 75 - 6 x 100 mm - (+) 1 x 75 - 2 x 100 mm
Pinzas	150 mm
Llave de rodillo	200 mm
Alicates con puntas semiredondas	150 mm
Tenaza hidráulica	240 mm
Adaptador macho con cuadradillo de 1/4" y hex de 1/4"	1 Pc
Martillo alemán	300 g
Cutter	1 Pc
Porta insertos magnético	1 Pc
Insertos	30 - 1/4"
Porta insertos con carraca	1 Pc
Flexómetro	5 m
Dimensiones maletín	400 x 270 x 120 mm
Peso neto	3 kg



0164

€ 82,00

**MALETA DE TELA CON UTILES Y ACCESORIOS**

Funcional maletín de tela ultra resistente con doble asa superior logada y práctica correa para el hombro. Compuesto por 59 herramientas y accesorios.



59 Pcs

Cr-V

Tenaza hidráulica	250 mm
Llaves hexagonales	1,5 - 2 - 2,5 - 3 - 4 - 5 - 6 - 8 - 10 mm
Alicates universales	180 mm
Tijeras	200 mm
Cutter	18 mm
Porta insertos magnético	1 Pc
Insertos	30 - 1/4"
Porta insertos con carraca	1 Pc
Martillo alemán	300 g
Destornilladores	(-) 3 x 75 - 5 x 100 mm - (+) 0 x 75 - 1 x 100 - 2 x 100 mm
Flexómetro	5 m
Llaves combinadas	7 - 8 - 10 - 13 - 17 - 19 mm

0172

**NEW** € 24,90

**MINI MALETA CON HERRAMIENTAS**



39 Pcs

Cr-V

Llaves hexagonales	1,5 - 2 - 2,5 - 3 - 4 - 5 - 5,5 - 6 mm
Alicate con articulación	150 mm
Insertos	20 Pcs
Porta insertos	1 Pc
Prolongación	60 mm
Destornilladores de precisión	(+) PH0, PH1, (-) SL2.4, SL3.0
Cutter	1 Pc
Martello	230 g
Flexómetro	3 mt
Tijeras	200 mm
Dimensiones maletín	320 x 190 x 80 mm
Peso neto	2,0 kg